

Projector

CP-X10000/CP-WX11000/CP-SX12000 User's Manual (detailed) – Operating Guide

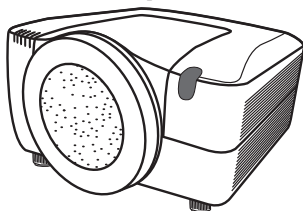

Thank you for purchasing this projector.

⚠ WARNING ▶ Before using this product, please read the "User's Manual - Safety Guide" and related manuals to ensure the proper use of this product. After reading them, store them in a safe place for future reference.

About this manual

Various symbols are used in this manual. The meanings of these symbols are described below.

⚠ WARNING This entry warns of a risk of serious personal injury or even death.

⚠ CAUTION This entry warns of a risk of personal injury or physical damage.

NOTICE This entry notices of fear of causing trouble.

 Please refer to the pages written following this symbol.

NOTE • The information in this manual is subject to change without notice.
• The manufacturer assumes no responsibility for any errors that may appear in this manual.
• The reproduction, transfer or copy of all or any part of this document is not permitted without express written consent.

Trademark acknowledgment

- Windows® is a registered trademark of Microsoft Corporation in the U.S. and/or other countries.
- VESA and DDC are trademarks of the Video Electronics Standard Association.
- Mac® is a registered trademark of Apple Inc.
- DVI is a trademark of Digital Display Working Group.
- HDMI, the HDMI logo and High-Definition Multimedia Interface are trademarks or registered trademarks of HDMI Licensing LLC.
- Trademark PJLink is a trademark applied for trademark rights in Japan, the United States of America and other countries and areas.

PJLink™

All other trademarks are the properties of their respective owners.

Contents



About this manual	1	EASY MENU	29
Contents	2	ASPECT, AUTO KEYSTONE, KEYSTONE,	
Introduction	3	KEYSTONE, PICTURE MODE, ECO MODE,	
Projector features	3	MIRROR, RESET, FILTER TIME, LANGUAGE,	
Important safety instruction (for the		ADVANCED MENU, EXIT	
moving)	3	PICTURE menu	31
Checking the contents of package	4	BRIGHTNESS, CONTRAST, GAMMA, COLOR TEMP,	
Attaching the lens unit	4	COLOR, TINT, SHARPNESS, ACTIVE IRIS, MY MEMORY	
Part names	5	IMAGE menu	34
Projector	5	ASPECT, OVER SCAN, V POSITION, H POSITION,	
Control panel	6	H PHASE, H SIZE, AUTO ADJUST EXECUTE	
Indicator lamp	6	INPUT menu	36
Rear panel	6	PROGRESSIVE, VIDEO NR, 3D-YCS, COLOR	
Remote control	7	SPACE, COMPONENT, VIDEO FORMAT, DIGITAL	
Setting up	8	FOMAT, DIGITAL RANGE, COMPUTER IN, FRAME	
Installation environment	8	LOCK, RESOLUTION	
Projection style	8	SETUP menu	40
Projection distance	9	AUTO KEYSTONE, KEYSTONE, KEYSTONE,	
Placement	10	ECO MODE, MIRROR, MONITOR OUT	
Supplementary anti-theft means	10	SCREEN menu	42
Connecting with your devices	11	LANGUAGE, MENU POSITION, BLANK, START UP,	
Connecting power supply	15	MyScreen, MyScreen Lock, MESSAGE, SOURCE	
Remote control	16	NAME, TEMPLATE, C.C.	
Putting batteries	16	OPTION menu	47
Transmitting condition	17	SOURCE SKIP, AUTO SEARCH, AUTO KEYSTONE,	
Changing the frequency of remote		DIRECT ON, AUTO OFF, SUTTER TIMER LAMP	
control signal	17	TIME, FILTER TIME, MY BUTTON, MY SOURCE,	
Using the REMOTE ID function	18	SERVICE	
Using as a wired remote control	18	NETWORK menu	56
Laser pointer	18	SETUP, PROJECTOR NAME, MY IMAGE,	
Operating	19	INFORMATION, SERVICE	
Turning on	19	SECURITY menu	61
Turning off	20	ENTER PASSWORD, SECURITY PASSWORD,	
Using the elevator feet	20	MyScreen PASSWORD, PIN LOCK, TRANSITION	
Using the functions for the lens	21	DETECTOR, MY TEXT PASSWORD, MY TEXT	
Displaying and switching the image	22	DISPLAY, MY TEXT WRITING	
Selecting an aspect ratio	23	Maintenance	67
Using the automatic adjustment feature	23	Lamp unit	67
Adjusting the position	24	Filter unit	69
Correcting the keystone distortion	24	Internal clock battery	70
Using the magnify feature	25	Others	70
Temporarily freezing the screen	25	Troubleshooting	71
Temporarily blanking the screen	26	Related messages	71
Temporarily shutting the screen	26	Regarding the indicator lamps	72
P by P (Picture by Picture)	27	Phenomena that may be easily	
Using the menu function	28	mistaken for machine defects	74
		Warranty and after-service	77
		Specifications	77

Introduction

Projector features

This projector has a capability to project various picture signals onto a screen. This projector requires only a minimal amount of space for installation and can produce a large projected image from even a short distance. Moreover, the projector has the following features to extend its potentiality for broad use.

- ✓ The **HDMI** port can support various image equipment which have digital interface to get clearer pictures on a screen.
- ✓ The super bright lamp and high quality optical system can fulfill the demands of professional uses.
- ✓ The selectable optional lens units and the super wide range of the lens shift feature will give much more chances to install the product wherever you want.
- ✓ The lens shutter can hide your inside operations and will help your presentation.
- ✓ The wealth of I/O ports is believed to support any business scene.
- ✓ This projector's network supports the PJLink™ standard.
- ✓ PJLink™ is a unified standard for operating and controlling data projectors. PJLink™ enables central control of projectors manufactured by different vendors and projectors can be operated by a controller. PJLink™ compliant equipment can be managed and controlled at any time and in any place, regardless of manufacturer.
For the command of PJLink™, see [User's Manual \(Technical\)](#)
For specifications of PJLink™, see the web site of the Japan Business Machine and Information System Industries Association.
URL: <http://pjlink.jbmia.or.jp>
- ✓ The unique Electric Dust Catcher Air filter system is expected to prevent air dust from getting into the projector and offers you less maintenance frequency.

Important safety instruction (for moving)

*For details, see the [User's Manual \(concise\)](#) or Safety Guide.

⚠ WARNING ▶ Always move the projector with two or more people. Place your hands in the dented parts on the bottom of the projector when carrying the projector.
▶ Remove all the attachments including the power cord and cables, from the projector when carrying the projector.

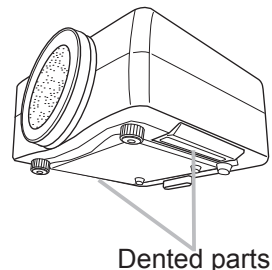

Checking the contents of package

Soon after purchasing this product, check that all the following items are included in the package. If any items should be missing, tell your dealer immediately.

- (1) Projector
- (2) Lens adapter
- (3) Hexagon wrench (for installation of the optional lens unit)
- (4) Power cord
- (5) Computer cable
- (6) Remote control with two batteries
- (7) User's manuals (a book and a CD)
- (8) Security label

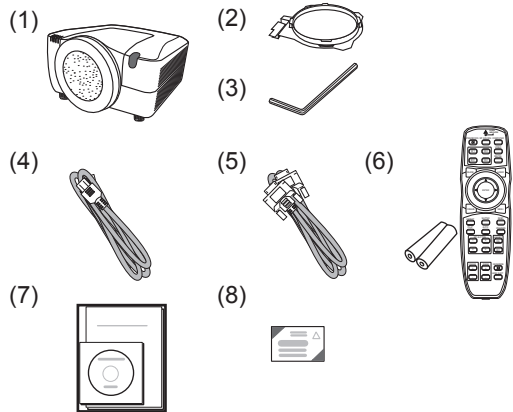

NOTE • This product is supplied without a lens unit so that you can choose from a range of lenses ([77](#)) that can meet your requirements. Ask your dealer about details, and prepare one or more lens unit together with this product.
• Some additional accessories or services may be required for your use. We recommend consult with your dealer beforehand.

CAUTION ► Keep the original packing materials, and use them correctly when transporting or storing the product.

Attaching the lens unit

Request your dealer to install the lens unit in the projector. Be sure to leave both removing and attaching the lens unit to the service personnel your dealer sent.

- WARNING** ► Use only the lens unit specified by the manufacturer.
- Leave both attaching and removing the lens unit to the service personnel your dealer sent.
 - Read and keep the user's manual of the lens unit.
 - Use special caution not to drop the lens unit or knock it against something.
 - Do not transport the projector to which the lens unit is attached.

CAUTION Keep the original packing materials for the lens unit, and use them correctly when transporting or storing the lens unit.

- NOTICE** ► Do not touch the lens surface directly.
- Keep the dust protector of the projector, and use it while no lens unit is attached to the projector.

Part names

Projector

- (1) Dust protector
- (2) Remote sensors (x 2) (📖17)
- (3) Exhaust vents
- (4) Filter cover (📖69)

The filter unit and intake vent are inside.

- (5) Control panel (📖6)
- (6) Rear panel (📖6)
- (7) Shutdown switch (📖73)
- (8) Lamp cover (📖67)

The lamp unit is inside.

- (9) **AC IN** (AC inlet) (📖15)
- (10) Power switch (📖19,20)
- (11) Security bar (📖10)
- (12) Security slot (📖10)
- (13) Dented part (x 2) (📖3)
- (14) Elevator feet (x 2) (📖20)

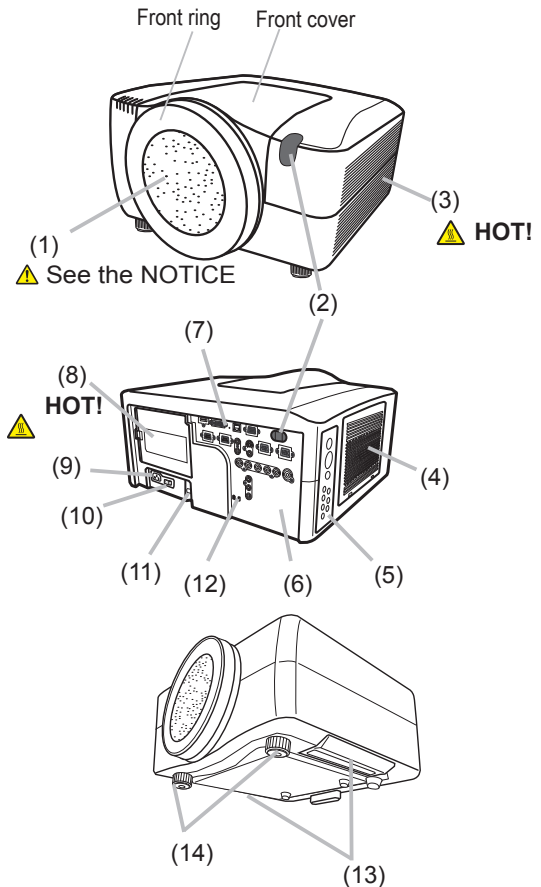

⚠ WARNING ▶HOT! : Do not touch around the lamp cover or the exhaust vents during use or just after use, since it is hot.

▶ Do not look into the lens or vents while the lamp is on, since the strong light is not good for your eyes.

▶ Do not grab the front cover or front ring to hold the projector, since you can drop the projector.

▶ Do not handle the elevator feet without holding the projector, since the projector may drop down.

⚠ CAUTION ▶ Maintain normal ventilation to prevent the projector from heating up. Do not cover, block or plug up the vents. Do not place anything that can stick or be sucked to the vents, around the intake vents. Clean the air filter periodically.

NOTICE ▶ Do not touch the lens surface directly.

▶ Keep the dust protector of the projector, and use it when no lens unit is attached to the projector.

Control panel

- (1) **STANDBY/ON** button (📖19,20)
- (2) **Cursor** buttons (▲/▼/◀/▶) (📖28)
- (3) **MENU** button (📖28)
- (4) **COMPUTER** button (📖22)
- (5) **VIDEO** button (📖22)
- (6) **DIGITAL** button (📖22)
- (7) **LENS SHIFT** button (📖21)
- (8) **ZOOM** button (📖21)
- (9) **FOCUS** button (📖21)
- (10) **SHUTTER** button (📖26)

The indicator will light in green while the menu of the function is displayed.

The indicator will blink in yellow while the lens shutter is closed.

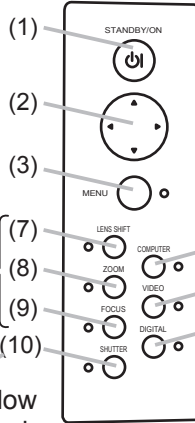

The indicator of group the selected input port belongs to will light in green.

Indicator lamp (📖72)

- (1) **POWER** indicator
- (2) **TEMP** indicator
- (3) **LAMP** indicator
- (4) **SECURITY** indicator
- (5) **SHUTTER** indicator

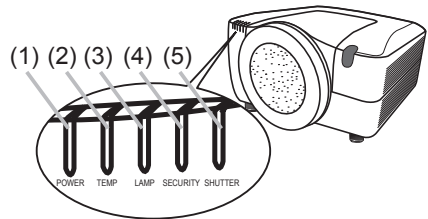

Rear panel (📖10)

- (1) **HDMI** port
- (2) **DVI-D** port
- (3) **LAN** port
- (4) **MONITOR OUT** port
- (5) **CONTROL IN** port
- (6) **CONTROL OUT** port
- (7) **REMOTE CONTROL IN** port
- (8) **REMOTE CONTROL OUT** port
- (9) **S-VIDEO** port
- (10) **VIDEO 1** port
- (11) **VIDEO 2** port
- (12) **COMPUTER IN1** port
- (13) **COMPUTER IN2** port
- (14) **BNC (G/Y, B/Cb/Pb, R/Cr/Pr, H, V)** ports
- (15) **Component (Y, Cb/Pb, Cr/Pr)** ports

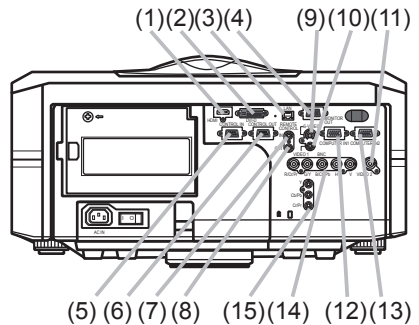

⚠ CAUTION ▶ Use the shutdown switch only when the projector is not turned off following the normal procedure, since pushing this switch stops operation of the projector without cooling it down.

Remote control

- (1) Laser pointer (📖18)
It is a beam outlet.
- (2) **LASER INDICATOR** (📖18)
- (3) **LASER** button (📖18)
- (4) **STANDBY/ON** button (📖19,20)
- (5) **ID (1-4)** button (📖18)
- (6) **COMPUTER** button (📖22)
- (7) **VIDEO** button (📖22)
- (8) **DIGITAL** button (📖22)
- (9) **MY SOURCE** button (📖22)
- (10) **LENS SHIFT** button (📖21)
- (11) **ZOOM +/-** button (📖21)
- (12) **FOCUS +/-** button (📖21)
- (13) **AUTO** button (📖23)
- (14) **POSITION** button (📖24)
- (15) **ASPECT** button (📖23)
- (16) **KEYSTONE** button (📖24)
- (17) **MAGNIFY ON/OFF** button (📖25)
- (18) **FREEZE** button (📖25)
- (19) **BLANK** button (📖26)
- (20) **SHUTTER** button (📖26)
- (21) **MY BUTTON (1-4)** button (📖49)
- (22) **P by P** button (📖27)
- (23) **MENU** button (📖28)
- (24) **ENTER** button : press the center point.
Cursor button: press the point ▲/▼/◀/▶ (📖28).
- (25) **RESET** button (📖28)
- (26) Wired remote control port (📖18)
- (27) Battery cover (📖16)
- (28) Battery holder (📖16)
- (29) Frequency switch (📖17)

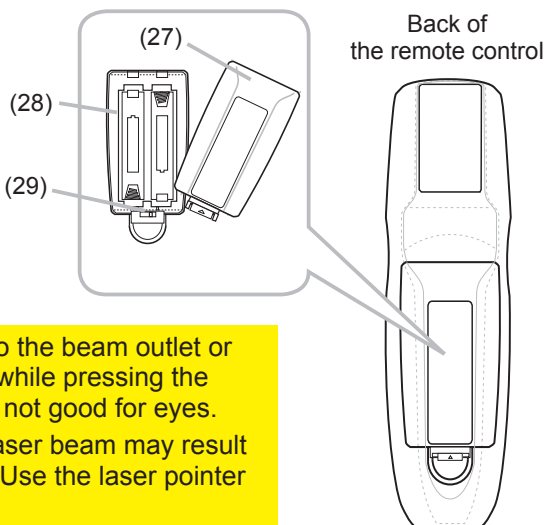
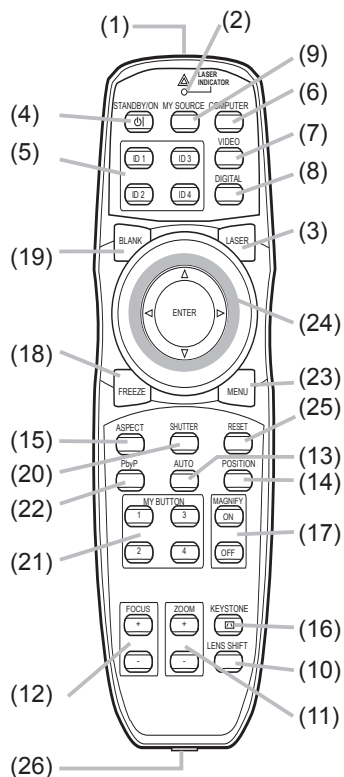

⚠ WARNING ▶ Do not look into the beam outlet or point the beam at people or pets while pressing the **LASER** button, since the beam is not good for eyes.

⚠ CAUTION ▶ Note that the laser beam may result in hazardous radiation exposure. Use the laser pointer only for pointing on the screen.

Setting up

Read this chapter through first. Then install the projector into place.

Installation environment

This product requires an installing place that is stable, cool and airy. Check your installation environment in accordance with the following.

- ⚠ **WARNING** ▶ Do not place the product on an unstable surface such as an uneven, tilted, or vibrating place.
- ▶ Do not place the product near water - for example, near a bathtub, washbowl, kitchen sink, or laundry tub; in a wet basement, near a swimming pool, beach; or outdoors.
- ⚠ **CAUTION** ▶ Do not place the product in a dusty, smoky, or humid place - for example, on a passage, in a smoking space, in a kitchen, or outdoors.
- ▶ Do not place the product near heat sources - for example, radiators, heat registers, stoves, or other product (including amplifiers) that produces heat.
- ▶ Do not place this product in a magnetic field.
- NOTICE** ▶ Do not place the product in a place where radio interference may be caused.
- ▶ Do not place the projector in a place where any strong lights hit the remote sensors.

Projection style

This projector can be used by the following projection styles. Choose the style suitable to your use.

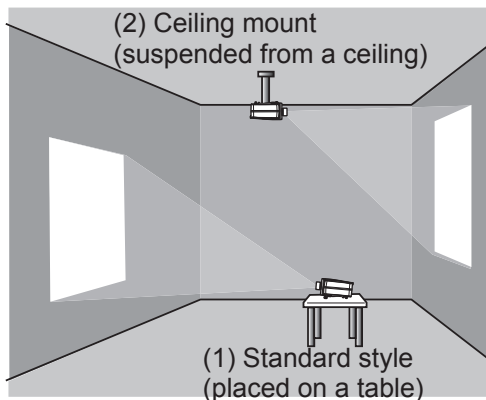

NOTE • In the case of ceiling mount, upward projection, or downward projection, the specified mounting accessories (☐77) and service are required to install the projector. Request them from your dealer. Ask your dealer for installation other than styles above.

- ⚠ **WARNING** ▶ Consult with your dealer about installation beforehand.
- ▶ Use only the mounting accessories the manufacturer specified, and leave installing and removing the projector with the mounting accessories to the service personnel.

Projection distance

Refer to the following to arrange the projector and your screen. The values shown in the following table were calculated for the model CP-X10000 with the standard lens unit SD-804 that is adjusted to the center position. See the user's manual of your lens unit for your case. The values differ for every combination of the projector and the lens unit.

* The values shown in the table are calculated for a full size screen: 1024×768

(a) Screen size (diagonal)

(b) Projection distance (±10%)

(c) Screen height (±10%), when the vertical lens shift is set full upward.

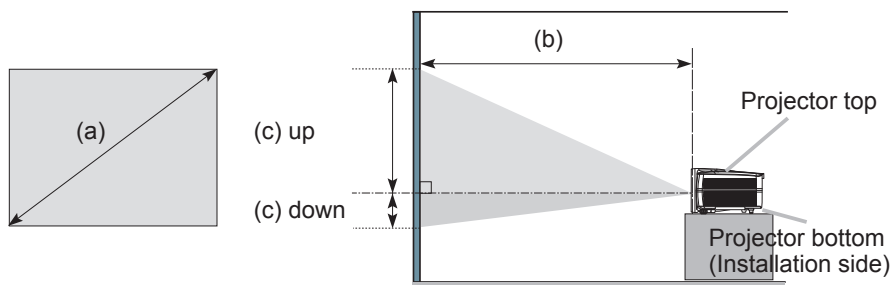

(a) Screen size [inch (m)]	4 : 3 screen				16 : 9 screen			
	(b) Projection distance [m (inch)]		(c) Screen height [cm (inch)]		(b) Projection distance [m (inch)]		(c) Screen height [cm (inch)]	
	min.	max.	down	up	min.	max.	down	up
40 (1.0)	1.7 (66)	2.3 (89)	-23 (-9)	84 (33)	1.3 (53)	1.8 (72)	-33 (-13)	83 (33)
60 (1.5)	2.6 (103)	3.5 (136)	-34 (-13)	125 (49)	2.1 (83)	2.8 (110)	-49 (-19)	124 (49)
70 (1.8)	3.1 (121)	4.0 (159)	-40 (-16)	146 (58)	2.5 (98)	3.3 (129)	-58 (-23)	145 (57)
80 (2.0)	3.5 (139)	4.6 (183)	-45 (-18)	167 (66)	2.9 (112)	3.8 (148)	-66 (-26)	165 (65)
90 (2.3)	4.0 (157)	5.2 (206)	-51 (-20)	188 (74)	3.2 (127)	4.3 (168)	-74 (-29)	186 (73)
100 (2.5)	4.4 (175)	5.8 (230)	-56 (-22)	209 (82)	3.6 (142)	4.7 (187)	-82 (-32)	207 (81)
120 (3.0)	5.4 (211)	7.0 (277)	-68 (-27)	251 (99)	4.4 (172)	5.7 (225)	-99 (-39)	248 (98)
150 (3.8)	6.7 (266)	8.8 (347)	-85 (-33)	313 (123)	5.5 (216)	7.2 (283)	-123 (-49)	310 (122)
200 (5.1)	9.0 (356)	11.8 (464)	-113 (-44)	418 (164)	7.4 (290)	9.6 (379)	-164 (-65)	414 (163)
250 (6.4)	11.3 (447)	14.8 (582)	-141 (-56)	522 (206)	9.2 (364)	12.0 (474)	-206 (-81)	517 (204)
300 (7.6)	13.6 (537)	17.8 (699)	-169 (-67)	627 (247)	11.1 (438)	14.5 (570)	-247 (-97)	620 (244)
350 (8.9)	15.9 (628)	20.7 (816)	-198 (-78)	731 (288)	13.0 (512)	16.9 (666)	-288 (-113)	724 (285)
400 (10.2)	18.2 (718)	23.7 (934)	-226 (-89)	835 (329)	14.9 (586)	19.4 (762)	-329 (-130)	827 (326)
500 (12.7)	22.8 (899)	29.7 (1168)	-282 (-111)	1044 (411)	18.6 (734)	24.2 (954)	-411 (-162)	1034 (407)
600 (15.2)	27.4 (1081)	35.6 (1403)	-339 (-133)	1253 (493)	22.4 (882)	29.1 (1145)	-493 (-194)	1241 (488)
700 (17.8)	32.0 (1262)	41.6 (1638)	-395 (-156)	1462 (576)	26.2 (1030)	34.0 (1337)	-576 (-227)	1447 (570)

NOTICE ▶ Do not use a polarized screen, since it can cause a red image.

Placement

In placing the projector in place in accordance with the preceding section "Projection distance" (📖9) heed the following too.

- ⚠️ **WARNING** ▶ Keep the projector away from anything that is easy to catch fire.
- ▶ Do not block or cover the openings on the projector, and keep sufficiently space for ventilation around the projector.
 - Do not use the projector on a cushiony surface such a rug, a carpet or bedding.
 - Keep the projector away from any light materials such as a piece of paper that can stick to the intake holes.
 - ▶ Do not use the projector on an unstable stand such as a cart.
 - ▶ Place the projector so that nothing enters to the inside of the projector.
 - Keep the projector away from any small things such as paperclips that can fall into the inside.
 - Keep the projector away from any liquids that can spill or leak into the product.
- ⚠️ **CAUTION** ▶ Keep the projector away from anything that is heat conductive such as metal.
- Do not use the projector on a metallic table.
 - ▶ Keep the projector away from anything that is weak in heat such as some kinds of plastics.
- NOTICE** ▶ Place the projector so that there is nothing that blocks the projection light to the screen.
- ▶ Avoid exposing directly the remote sensor to any strong lights.

Supplementary anti-theft means

This projector has the security bar for a commercial anti-theft chain or wire up to 10 mm in diameter, and also the security slot for the Kensington lock. For details, see the manual of your security tool.

NOTE • These are not provided as comprehensive theft preventions but supplemental measures.

⚠️ **WARNING** ▶ Do not use the security slot to prevent the projector from falling down, since it is not designed for it.

⚠️ **CAUTION** ▶ Do not place the anti-theft chain or wire near the projector's exhaust vents, since the chain or wire heated by the hot exhaust gas may cause burns.

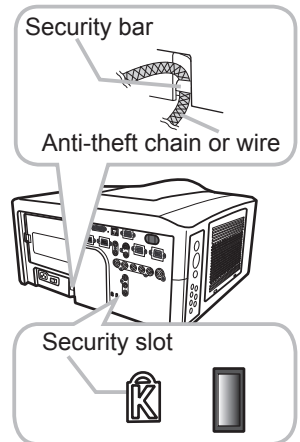

Connecting with your devices

Before connecting the projector to your devices, check the manual of the device in order to make sure that the device is suitable to connect with this projector and to check what is required for the connection.

Consult your dealer when the required accessory did not come with the product or the accessory is damaged. It may be regulated under some standard.

After making sure that the projector and the devices are turned off, perform the connection, according to the following instructions. Refer to the figures in subsequent pages.

NOTE • For this product, the optional cable cover is ready to be purchased. To place an order for it, please tell your dealer the type name of it ([p.77](#)).

⚠ WARNING ► Use only the accessories specified or recommended by manufacturer. Modify neither a projector nor accessories.

► Do not connect or disconnect the projector with devices while they are connected to a power supply except for the cases directed by the manuals of devices.

⚠ CAUTION ► Some connecting cable may have to have a specific length, or a ferrite core at the end to connect to the projector, under the regulation of electro-magnetic interference. When a ferrite core is attached to the specified cable only at one end, connect to the projector the end that the ferrite core is attached at.

► Be careful not to set a connector into a wrong port or with a wrong way.

► Be careful not to damage the cables. Route the cables not to be stepped on and pinched out.

NOTICE ► Do not turn your device on prior to the projector, except for the cases directed by the manuals of devices.

(continued on next page)

Connecting your devices (continued)

Example of connecting with VCR or DVD players

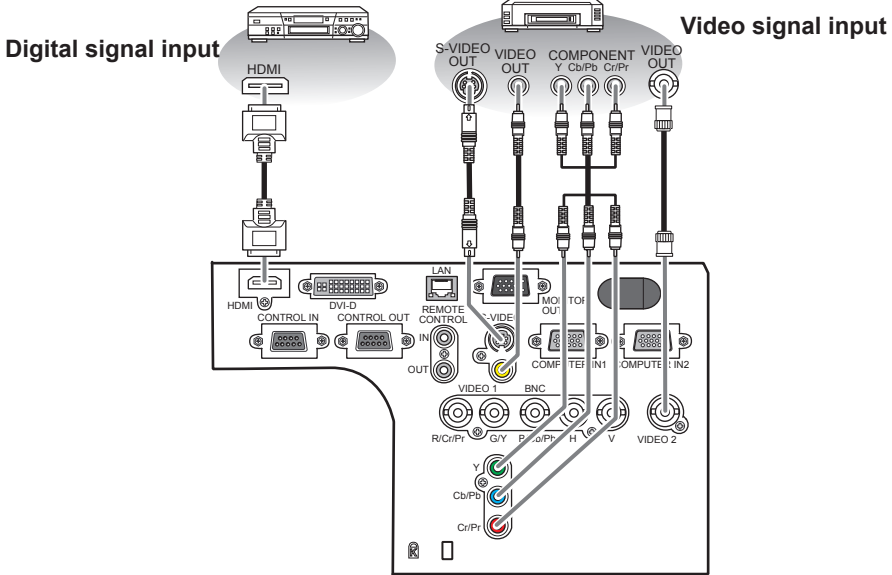

Example of connecting with computers

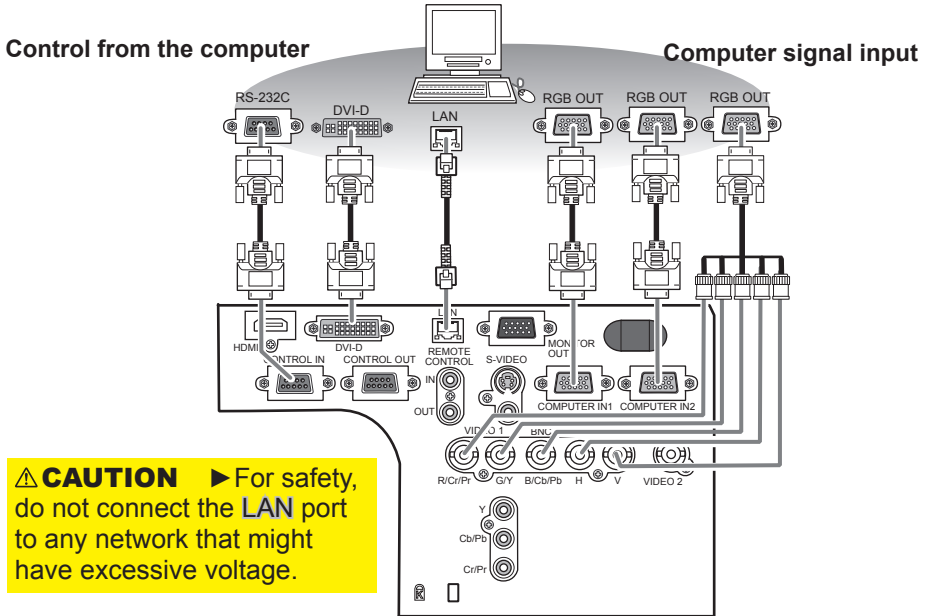

⚠ CAUTION ▶ For safety, do not connect the LAN port to any network that might have excessive voltage.

(continued on next page)

Connecting your devices (continued)

Example of connecting with another projector or a display device

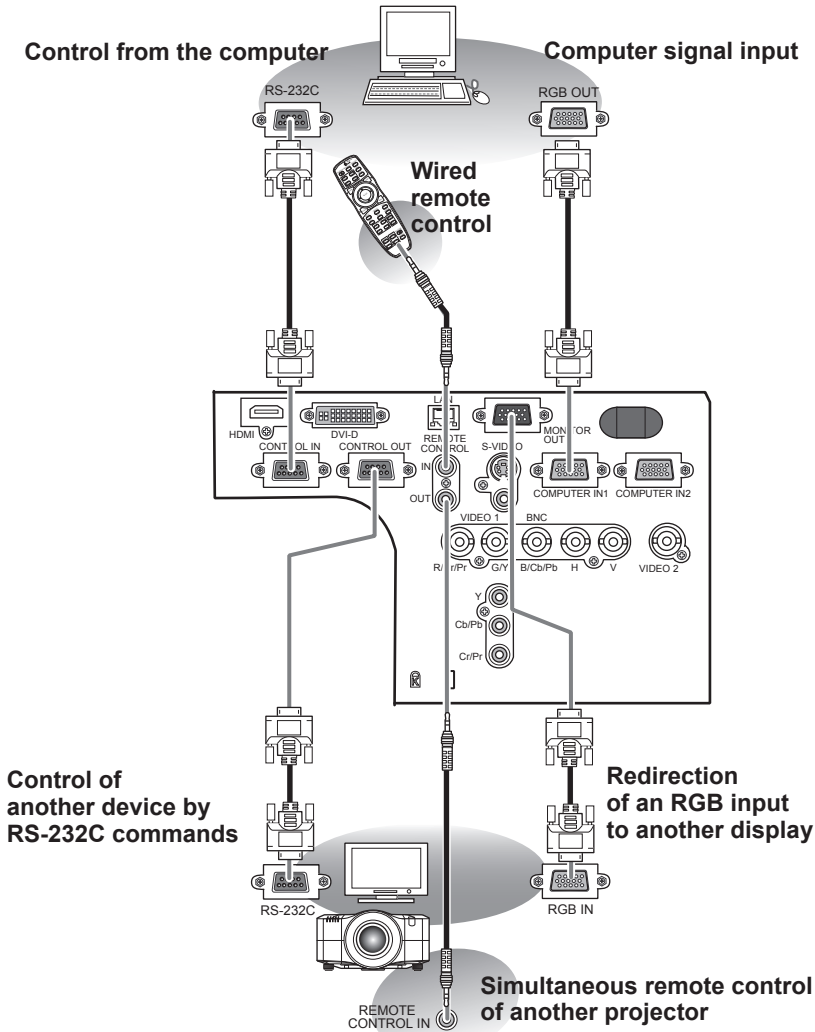

Connecting your devices (continued)

NOTE • Be sure to read the manuals for devices before connecting them to the projector, and make sure that all the devices are suitable to be connected with this product.

- Before connecting to a PC, check the signal level, the signal timing, and the resolution.
- Be sure to consult to the administrator of the network. Do not connect **LAN** port to any network that might have excessive voltage.
- Some signal may need an adapter to input this projector.
- Some PCs have multiple screen display modes that may include some signals which are not supported by this projector.
- Although the projector can display signals with resolution up to UXGA (1600X1200), the signal will be converted to the projector's panel resolution before being displayed. The best display performance will be achieved if the resolutions of the input signal and the projector panel are identical.
- While connecting, make sure that the shape of the cable's connector fits the port to connect with. And be sure to tighten the screws on connectors with screws.
- When connecting a laptop PC to the projector, be sure to activate the PC's external RGB output. (Set the laptop PC to CRT display or to simultaneous LCD and CRT display.) For details on how this is done, please refer to the instruction manual of the corresponding laptop PC.
- When the picture resolution is changed on a computer depending on an input, automatic adjustment function may take some time and may not be completed. In this case, you may not be able to see a check box to select "Yes/No" for the new resolution on Windows. Then the resolution will go back to the original. It might be recommended to use other CRT or LCD monitors to change the resolution.
- In some cases, this projector may not display a proper picture or display any picture on screen. For example, automatic adjustment may not function correctly with some input signals. An input signal of composite sync or sync on G may confuse this projector, so the projector may not display a proper picture.
- The **HDMI** and **DVI-D** ports of this model are compatible with HDCP (High-bandwidth Digital Content Protection) and therefore capable of displaying a video signal from HDCP compatible DVD players or the like.

About Plug-and-Play capability

Plug-and-Play is a system composed of a computer, its operating system and peripheral equipment (i.e. display devices). This projector is VESA DDC 2B compatible. Plug-and-Play can be used by connecting this projector to a computer that is VESA DDC (display data channel) compatible.

- Take advantage of this feature by connecting an RGB cable to the **COMPUTER IN1** port (DDC 2B compatible). Plug-and-Play may not work properly if any other type of connection is attempted.
- Please use the standard drivers in your computer as this projector is a Plug-and-Play monitor.

NOTE for HDMI

- The **HDMI** supports the following signals.
 - Video signal : 480i@60,480p@60,576i@50, 576p@50,720p@50/60,1080i@50/60, 1080p@50/60
 - PC signals : See User's Manual (detailed) Technical
- This projector can be connected with another equipment that has HDMI or DVI connector, but with some equipment the projector may not work properly, something like no video.
- Be sure to use an HDMI cable that has the HDMI logo.
- When the projector is connected with a device having DVI connector, use a DVI to HDMI cable to connect with the **HDMI** input.

Connecting power supply

In accordance with the warnings shown below, connect the AC inlet of the projector to the proper power outlet. The following walks you through the connection.

1. Make sure that the power switch of the projector is set to the off-position (marked with "O").
2. Insert the socket end of the power cord into the **AC IN** (AC inlet) of the projector.
3. Plug the other end of the power cord into the power outlet.

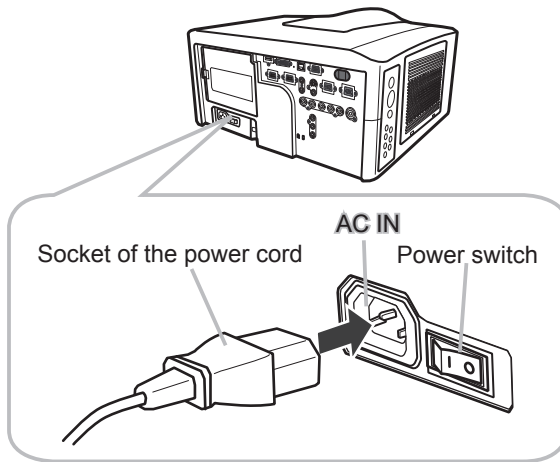

⚠ WARNING ▶ Do not connect the projector to a power supply when the lens unit is not attached.

▶ Use this projector from only the specified power supply in accordance with the label indication on the projector.

▶ Use a power outlet that is close to the projector and easily accessible.

▶ Do not overload the outlet, since overloading can result in a fire or an electric shock.

▶ Use only the power cord that came with this product and is suitable for your power supply. If the suitable power cord did not come with this product, consult your dealer.

▶ Do not use a damaged power cord. If the power cord you need is damaged, ask your dealer for a new power cord of the same type.

▶ Do not handle the power cord with wet hands.

▶ Do not repair or modify the power cord.

▶ Be careful not to damage the power cord. Route the power cord so that it is not likely to be walked on or pinched by items placed upon or against them.

▶ Connect firmly the power cord not to result in loose connection. Do not use a loose or unsound power outlet.

Remote control

Putting batteries

The remote control needs the two batteries of the following type.

HITACHI MAXELL, part number LR6 or R6P

The batteries that came with the product are a type suitable to this remote control.

The following walks you through loading batteries into the remote control.

1. Remove the battery cover in the back of the remote control. Push lightly the knob of the battery cover while pulling it up.
2. Put the batteries into the battery holder, according to the polarity markings "+" and "-" inside the holder.
3. Put the battery cover back into place until it clicks.

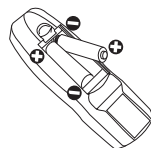

NOTE • If the remote control malfunctions, try replacing the batteries with fresh ones.

⚠ WARNING ► Be careful not to press the **LASER** button when loading the batteries. It is dangerous if a laser beam is unintentionally turned on. Please refer to the section "Laser pointer" (📖 18).

► Be careful of handling batteries, since a battery can cause explosion, cracking or leakage that could result in a fire, injury, or environment pollution.

- Use only the specified batteries. Do not use batteries of different types.
- When replacing, replace both of the batteries with new batteries of the same type. Do not use a new battery with a used battery.
- Do not use a battery with damage, such as scratches, dents, rust or leakage.
- Make sure the plus and minus terminals are correctly aligned when loading a battery.
- Do not work on a battery; for example recharging or soldering.
- If the remote control is not used for a long period of time, remove the batteries.
- Keep batteries in a dark, cool and dry place. Never expose a battery to a fire or water.
- Keep batteries away from children and pets.
- When a battery leaked, wipe the leakage out well with a waste cloth. If the leakage adhered to your body, immediately rinse it well with water. When a battery leaked in the battery holder, replace the batteries after wiping the leakage out.
- Obey the local laws on disposing a battery.

Transmitting condition

The remote control works with the remote sensors on the projector using infrared light (Class 1 LED). The remote sensor senses the remote control signals reached into the range within 60 degrees (to right and left) and 3 meters about from the sensor.

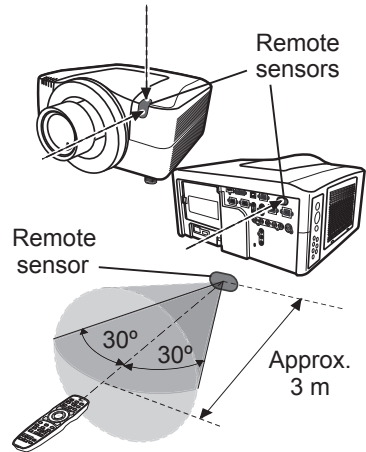

NOTE • You can inactivate one or two sensors from the three sensors using the item REMOTE RECEIVE. of the SERVICE menu under the OPTION menu.
 • When you want to use two or more projectors of this type at the same time and the same place, utilize the REMOTE ID function. The buttons of **ID 1**, **ID 2**, **ID 3** and **ID 4** on the remote control can name the projector given the same ID number as the button by the item REMOTE ID of the SERVICE menu under the OPTION menu.

NOTICE ▶ Avoid exposing directly the remote sensor to any strong lights.
 ▶ Do not put anything between the remote control and the remote sensor on the projector, since it may interfere with transmission of the remote control signals.

Changing the frequency of remote control signal

The accessory remote control has the choice of mode 1 or mode 2, in the frequency of its signal. If the remote control does not function properly, attempt to change the signal frequency. Please remember that the “REMOTE FREQ.” in SERVICE item of OPTION menu (🔑51) of the projector to be controlled should be set to the same mode as the remote control.

To set the mode of the remote control, slide the knob of the frequency switch inside the battery cover into the position indicated by the mode number to choose.

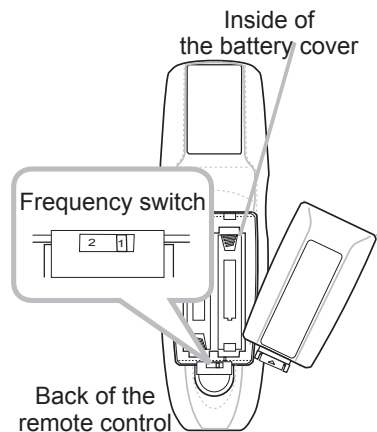

Using the REMOTE ID function

This is the function to define which projector is controlled by the remote control. Utilize this function when you use some projectors of the same type at the same time.

1. Set the ID number to the projector beforehand, referring to the item "REMOTE ID" item (p.52).
2. Press a ID button on the remote control. The ID button selected will light for 3 seconds.

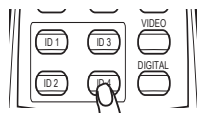

NOTE • Each time you press any button (except ID buttons), the ID button of current selected ID number will light.
 • To confirm the projector's current ID, press any ID button for 3 seconds. Its number will be shown on each screen regardless of set ID of projector.

Using as a wired remote control

The accessory remote control works as a wired remote control, when the wired control port at the bottom of the remote control connects with the **REMOTE CONTROL** port on the back of the projector via an audio cable with 3.5 diameter stereo mini plugs. This function is useful when a wireless remote signal may not reliably reach the projector.

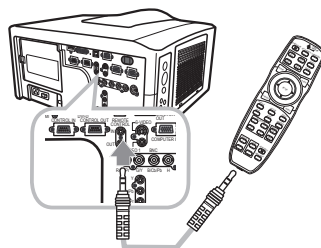

NOTE • To connect the remote control with the projector, use an audio cable with 3.5 diameter stereo mini plugs.

Laser pointer

This remote control has a laser pointer in place of a finger or rod. The laser beam works and the **LASER INDICATOR** lights while the **LASER** button is pressed.

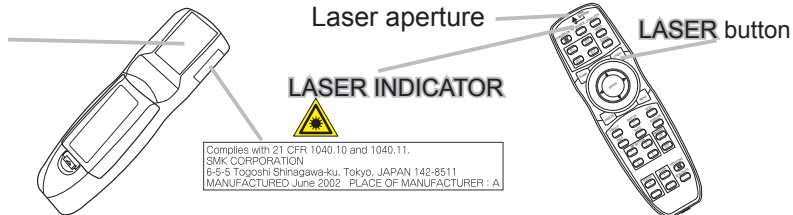

Complies with 21 CFR 1040.10 and 1040.11.
 SMK CORPORATION
 6-5-5 Toposhi Shinagawa-ku, Tokyo, JAPAN 142-8511
 MANUFACTURED June 2002 PLACE OF MANUFACTURER : A

▲ WARNING ► Use the laser beam of the remote control only for the pointer on the screen. Do not apply the laser beam to anything except the screen.
 • Never hit eyes by the laser beam since the laser beam can injure eyes.
 • Do not apply the laser beam to anything except the screen.

Operating

Turning on

The following walks you through the steps to turn the projector on. For other devices, follow the manual of each.

1. Make sure that the power cord is firmly and correctly connected to the projector and the outlet.
2. Press down the side marked "I" on the power switch.
The **POWER** indicator will light up in steady orange.
Then wait for the buttons to become ready. It may take several seconds.
3. Press the **STANDBY/ON** button (on the projector or the remote control).
The projection lamp will light up and the **POWER** indicator will begin blinking in green. When the power is completely on, the indicator will stop blinking and light in steady green.

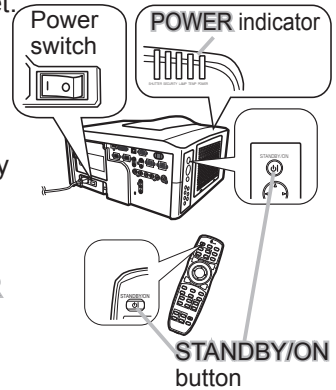

To display the picture, select an input signal according to the section "Displaying and switching the image" (📖22).

NOTE • When the item DIRECT ON of the OPTION menu is set to the ON, and that the projector was turned off by only the power switch without using the **STANDBY/ON** button, switching the power switch on turns the projector on without the formal procedure shown above.

⚠ WARNING ▶ Do not look directly into the lens or the openings on the projector while the lamp is on.

▶ Do not approach the lamp cover and the exhaust vents, while the projection lamp is on.

NOTICE ▶ Do not turn your device on prior to the projector, except for the cases directed by the manuals of devices.

Turning off

The following walks you through the steps to turn the projector off.

1. Press the **STANDBY/ON** button on the projector or the remote control.
The message "Power off?" will appear on the screen for about 5 seconds.
2. Press the **STANDBY/ON** button again while the message is shown.
The projector lamp will go off, and the **POWER** indicator will begin blinking in orange.
Then the **POWER** indicator will stop blinking and light in steady orange when lamp cooling is complete.
3. After making sure that the **POWER** indicator lights in steady orange, and press down the side marked "O" on the power switch.
The **POWER** indicator will go off.

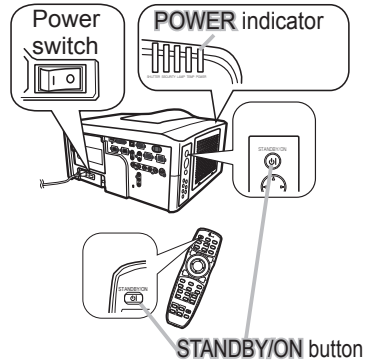

For other devices, follow the manual of each.

NOTE • Use the shutdown switch only when the projector can be not turned off by normal procedure.

⚠ WARNING ► Do not approach the lamp cover and the exhaust vents for a while after the lamp goes out, since they may be hot and could cause burns.

NOTICE ► Turn your device off prior to the projector, except for the cases directed by the manuals of devices.

Using the elevator feet

Lengthening or shortening the length of the elevator feet shifts the projection position and the projection angle.

Turn the elevator feet each to adjust their length

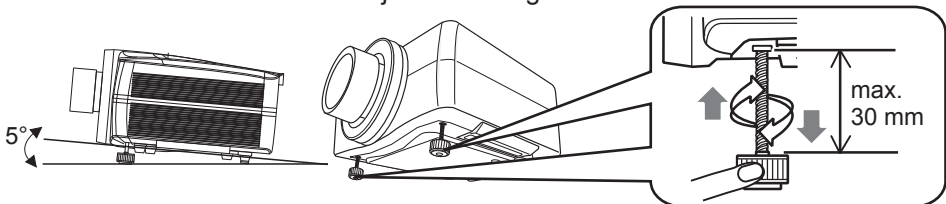

⚠ WARNING ► Do not lengthen the elevator feet to 30 mm or more. The foot lengthened exceeding the limit may come off and drop the projector down, and result in an injury or damaging the projector.

⚠ CAUTION ► Do not place the projector with an inclination of 5 degrees or more. The projector leaned exceeding the limit could cause malfunction and shorten the life of the projector.

Using the functions for the lens

ZOOM / FOCUS

Press the **ZOOM / FOCUS** button. The ZOOM / FOCUS dialog will appear. Adjust the zoom / focus using the ◀/▶ button while the dialog is displayed. Press the ▼ button to select "EXIT" on the dialog. It finishes the OSD menu.

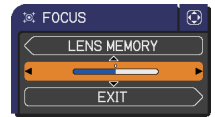
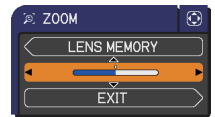

NOTE • The adjustable range of ZOOM and FOCUS varies depending on the lens unit mounted on the projector to maintain picture quality. Therefore ZOOM or FOCUS adjustments may not reach the end of the bar indicators in the dialog, and that is not a failure.

LENS SHIFT

Press the **LENS SHIFT** button. The LENS SHIFT dialog will appear. Using the ▲/▼/◀/▶ buttons while the dialog is displayed shifts the lens.



CENTERING

- **In the LENS SHIFT dialog:**
Press the **DIGITAL** button.
- **In the standby mode:**
Press the **LENS SHIFT** and the **DIGITAL** buttons for 3 seconds at the same time.
- While the lens is shifting, the menu will disappear and the icon of hourglass will appear on screen. Shifting may take some time. Depending on the case, it may reach one minute.
- The LENS SHIFT indicator lights up or blinks in green while the lens is shifting. Then the indicator will stop blinking and light for 3 seconds in steady green when the centering is complete.
- When the lens is located in the center already, pressing the **DIGITAL** button in the LENS SHIFT dialog lights in steady green the LENS SHIFT indicator for 3 seconds.

LENS MEMORY SAVE / LOAD / CLEAR

This projector is equipped with memory functions for the lens adjustments (zoom, focus and shift).

To display the LENS MEMORY dialog, select the LENS MEMORY on the ZOOM, FOCUS or LENS SHIFT dialog. Then the LENS MEMORY dialog will appear.

- **SAVE:** To save the current lens adjustments, select a SAVE-(1-3) and press ▶ or **ENTER** button.
- **LOAD:** To load a saved adjustments, select the LOAD-(1-3) and press ▶ or **ENTER** button. When the **MY BUTTON** button is allocated to the LOAD-(1-3) the memory can be loaded without the LENS MEMORY dialog.

LENS MEMORY					
	ZOOM	FOCUS	LENS SHIFT		LENS TYPE
			V	H	
CURRENT	64	64	+80	-22	3
SAVE-1	128	0	-128	0	2
SAVE-2	100	55	+127	0	5
SAVE-3					
LOAD-1					
LOAD-2					
LOAD-3					
CLEAR LENS MEMORY					
◀:RETURN ▶:OK					

- **CLEAR:** Selecting the CLEAR LENS MEMORY in the LENS MEMORY dialog displays CLEAR LENS MEMORY dialog. Select the number to be cleared using ▲/▼ buttons and press the ▶ button. The dialog to check your intention will come out. Then press the ▶ button again in the dialog.

Displaying and switching the image

1. Press the **COMPUTER** button to select an input port for the RGB signal.

Each time you press the button, the projector switches its RGB input port from the current port as below.

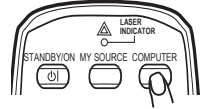

→ COMPUTER IN1 → COMPUTER IN2 → BNC

- While ON is selected for AUTO SEARCH item in OPTION menu, the projector will keep checking every port sequentially till an input signal is detected (47). If **COMPUTER** button is pushed when **VIDEO 1**, **VIDEO 2**, **S-VIDEO**, Component, **HDMI** or **DVI-D** port is selected, the projector will check **COMPUTER IN1** port first.

1. Press the **VIDEO** button to select an input for video signal.
- Each time you press the button, the projector switches its video input port as below.

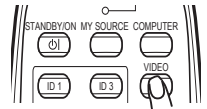

COMPONENT (Y, Cb/Pb, Cr/Pr) → S-VIDEO → VIDEO 1 → VIDEO 2

- While ON is selected for AUTO SEARCH item in OPTION menu, the projector will keep checking every port sequentially till an input signal is detected (47). If **VIDEO** button is pushed when **COMPUTER IN1** or **COMPUTER IN2** port is selected, the projector will check Component port first.

1. Press the **DIGITAL** button to select an input for digital signal.
- Each time you press the button, the projector switches its digital input port as below.

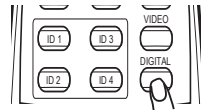

HDMI ↔ DVI-D

- While ON is selected for AUTO SEARCH item in OPTION menu, the projector will keep checking every port sequentially till an input signal is detected (47). If **DIGITAL** button is pushed when Component, **S-VIDEO**, **VIDEO 1** or **VIDEO 2** port is selected, the projector will check **HDMI** port first.

1. Press the **MY SOURCE** button on the remote control. The input signal will be changed into the signal you set as **MY SOURCE**(49).

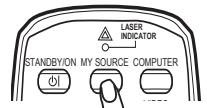

- This function also can use for document camera. Select the input port that connected the document camera.

Selecting an aspect ratio

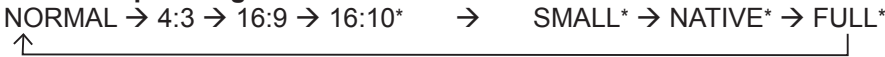
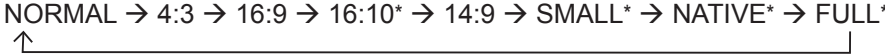
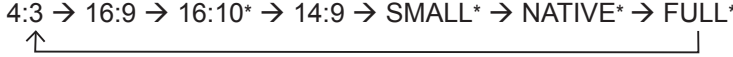
1. Press the **ASPECT** button on the remote control.
 - Each time you press the button, the projector switches the mode for aspect ratio in turn.
 - For a computer signal
 NORMAL → 4:3 → 16:9 → 16:10* → SMALL* → NATIVE* → FULL*
 
 - For an HDMI or DVI-D signal
 NORMAL → 4:3 → 16:9 → 16:10* → 14:9 → SMALL* → NATIVE* → FULL*
 
 - For a video signal, s-video signal or component video signal
 4:3 → 16:9 → 16:10* → 14:9 → SMALL* → NATIVE* → FULL*
 
 - For no signal
 4:3 (fixed, except CP-WX11000) / FULL (fixed, CP-WX11000)
 - *16:10 / FULL: CP-WX11000 only. NATIVE: Except CP-X10000. SMALL: Except CP-WX11000.
 - The NORMAL mode keeps the original aspect ratio of the signal.

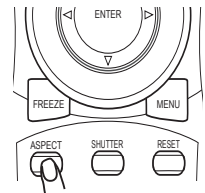

Using the automatic adjustment feature

1. Press the **AUTO** button on the remote control.
 - Pressing this button performs the following.
 - For a computer signal
 The vertical position, the horizontal position and the horizontal phase will be automatically adjusted. Make sure that the application window is set to its maximum size prior to attempting to use this feature. A dark picture may still be incorrectly adjusted. Use a bright picture when adjusting.
 - For a video signal and s-video signal
 The video format best suited for the respective input signal will be selected automatically. This function is available only when the AUTO is selected for the VIDEO FORMAT item in the INPUT menu (37). The vertical position and horizontal position will be automatically set to the default.
 - For a component video signal
 The vertical position, horizontal position and horizontal phase will be automatically set to the default.
 - The automatic adjustment operation requires approx. 10 seconds. Also please note that it may not function correctly with some input. When this function is performed for a video signal, a certain extra such as a line may appear outside a picture.
 - The items adjusted by this function may vary when the FINE or DISABLE is selected for the AUTO ADJUST item of the SERVICE item in the OPTION menu (50).

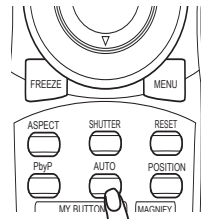

Adjusting the position

1. Press the **POSITION** button on the remote control when no menu is indicated.
The “POSITION” indication will appear on the screen.
2. Use the **▲/▼/◀/▶** cursor buttons to adjust the picture position.
When you want to reset the operation, press the **RESET** button on the remote control during the operation.
To complete this operation, press the **POSITION** button again. Even if you do not do anything, the dialog will automatically disappear after a few seconds.

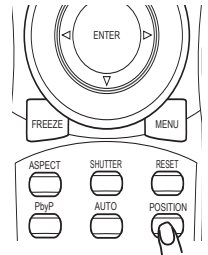

- When this function is performed on a video signal, s-video signal or component video signal, some image such as an extra-line may appear at outside of the picture.
- When this function is performing on a Video signal, S-Video signal, or component signal of 480i@60 or 576i@50 input the range of this adjustment depends on the OVER SCAN in IMAGE menu (📖34). It is not possible to adjust when the OVER SCAN is set to 10.

Correcting the keystone distortion

1. Press the **KEYSTONE** button on the remote control. A dialog will appear on the screen to aid you in correcting the distortion.
2. Use the **▲/▼** cursor buttons to select **AUTO** or **MANUAL** operation, and press the **▶** button to perform the following.
 - 1) **AUTO** executes automatic vertical keystone correction.
 - 2) **MANUAL** displays a dialog for keystone correction.
Use the **▲/▼** cursor buttons to select the direction to correct (☐ or ☐) then use the **◀/▶** buttons for adjustment.

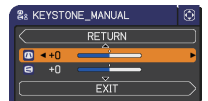
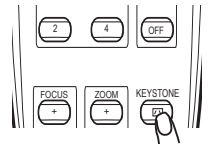
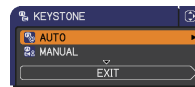

To close the dialog and complete this operation, press the **KEYSTONE** button again. Even if you don't do anything, the dialog will automatically disappear after a few seconds.

- The adjustable range of this function will vary among inputs. For some input, this function may not work well.
- When V:INVERT or H&V:INVERT is selected to the MIRROR item in the SETUP menu, if the projector screen is inclined or angled downward, this function may not work correctly.
- When the zoom adjustment is set to the TELE (telephoto focus), this function may be excessive. This function should be used when the zoom adjustment is set to the full WIDE (wide-angle focus) whenever possible.
- When the projector is placed on the level (about $\pm 3^\circ$), this function may not work.
- When the vertical lens shift is not set fully upward (not set fully downward for the optional lens type USL-801 only (📖51)), this function may not work well.
- When the horizontal lens shift is not set to the center, this function may not work well.
- This function will be unavailable when Transition Detector is on (📖64).

Using the magnify feature

1. Press the **ON** button of **MAGNIFY** on the remote control.
 - The “MAGNIFY” indication will appear on the screen and the projector will go into the MAGNIFY mode. In the Magnify mode, the picture will be zoomed. The indication will disappear in several seconds with no operation.
2. Use the **▲/▼** cursor buttons to adjust the zoom level. To move the zoom area, press the **POSITION** button in the MAGNIFY mode, then use the **▲/▼/◀/▶** cursor buttons to move the area. And to finalize the zoom area, press the **POSITION** button again.
 - To exit from the MAGNIFY mode and restore the screen to normal, press the **OFF** button of **MAGNIFY** on the remote control.
 - The projector automatically exits from the MAGNIFY mode when the input signal is changed or when the display condition is changed.
 - In the MAGNIFY mode, the keystone distortion condition may vary, it will be restored when the projector exits from the MAGNIFY mode.

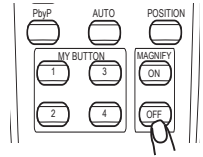

NOTE • The zoom level can be finely adjusted. Closely watch the screen to find the level you want.

Temporarily freezing the screen

1. Press the **FREEZE** button on the remote control.
 - The “FREEZE” indication will appear on the screen (however, the indication will not appear when the OFF is selected for the MESSAGE item in the SCREEN menu (45)), and the projector will go into the FREEZE mode, which the picture is frozen.
 - To exit the FREEZE mode and restore the screen to normal, press the **FREEZE** button again.
 - The projector automatically exits from the FREEZE mode when some control buttons are pressed.
 - If the projector continues projecting a still image for a long time, the LCD panel might possibly be burned in. Do not leave the projector in the FREEZE mode for too long.

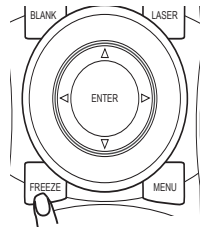

Temporarily blanking the screen

1. Press the **BLANK** button on the remote control.
 - The blank screen will be displayed instead of the screen of input signal. Please refer to the BLANK item in SCREEN menu (☞42).
To exit from the blank screen and return to the input signal screen, press the **BLANK** button again.

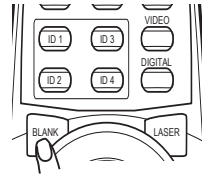

- The projector automatically exits from the BLANK mode when some control buttons are pressed.

Temporarily shutting the image

1. Pressing the **SHUTTER** button closes or opens the mechanical lens shutter.
 - The closed shutter blocks the projection light, so that it can black out the screen.
 - The **SHUTTER** indicator on the projector blinks while the shutter is closed.
 - The projector will turn off automatically when the time set up by the SHUTTER TIMER passes (☞48).
 - When turning the power off with the **STANDBY/ON** button (☞20), the lens shutter closed opens automatically. If the power supply is stopped while opening or closing the lens shutter, the moving of the lens shutter is stopped too. However, when turning the projector on, the lens shutter closed or incompletely opened opens automatically.

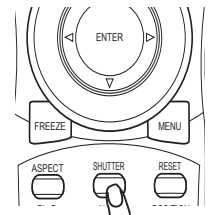

PbyP (Picture by Picture)

The **PbyP** is a function to display two different picture signals on a screen that is split in two areas for each signal. Some of functions can be used with the same operation as it for the normal mode (not in the **PbyP** mode). There are some operations available only in the **PbyP** mode.

Starting the PbyP

Press the **PbyP** button on the remote control, then the **PbyP** function will be started. To quit the **PbyP** mode, press the button again.

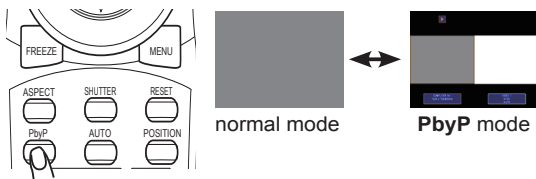

Showing the setting information

The setting information is displayed for several seconds when the **PbyP** function is started. It shows the input signal information for each area. Also, there will be a yellow frame with one of the area that is the main area where most of operations are effective. The information can be displayed using the cursor buttons $\blacktriangle/\blacktriangledown/\blacktriangleleft/\blacktriangleright$ when the setting information is not on the screen.

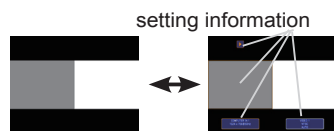

Changing the main area

Most of operations are effective for the main area only. Also the audio input signal paired with the picture input signal for the main area is assigned as the audio output signal. The main area can be changed using the cursor buttons $\blacktriangleleft/\blacktriangleright$ when the setting information is on the screen.

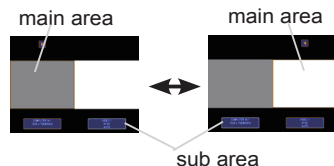

Changing the picture input signal

Press the **COMPUTER**, **VIDEO** or **DIGITAL** button while in the **PbyP** mode, the menu to select the input signal will be appeared. Choose a signal using the cursor buttons $\blacktriangle/\blacktriangledown$. If you want to change the signal in the sub area, switch the main area using the cursor buttons $\blacktriangleleft/\blacktriangleright$ first. Displaying the same signal on the both areas is not allowed. For other combinations of the input signal, refer to the right table. Any combinations marked with X can not be selected.

<signal combination>

	Sub	COMPUTER IN1	COMPUTER IN2	BNC	HDMI	DVI-D	Component	Scart RGB	S-Video	Video 1	Video 2
Main											
COMPUTER IN1	0	0	0	0	0	0	0	0	0	0	0
COMPUTER IN2	0	0	0	0	0	0	0	0	0	0	0
BNC	0	0	0	0	0	0	0	0	0	0	0
HDMI	0	0	0	0	0	X	X	X	X	X	X
DVI-D	0	0	0	0	X	0	X	X	X	X	X
Component	0	0	0	0	0	0	0	0	0	0	0
Scart RGB	0	0	0	0	X	X	X	0	X	X	X
S-Video	0	0	0	0	X	X	X	0	X	X	X
Video 1	0	0	0	0	X	X	X	0	X	0	X
Video 2	0	0	0	0	X	X	X	0	X	X	0

Using the PbyP SWAP function

Press the **MY BUTTON** assigned the **PbyP SWAP** (49). The position of the both area is exchanged without any setting change.



NOTE •For some signals, it may not be displayed correctly in the **PbyP** mode, even if it can be displayed properly in the normal mode.

Using the menu function

This projector has the following menus: PICTURE, IMAGE, INPUT, SETUP, SCREEN, OPTION, NETWORK, SECURITY and EASY MENU. The EASY MENU consists of functions often used, and the other menus are classified into each purpose and brought together as the ADVANCED MENU. Each of these menus is operated using the same methods with the ▲/▼/◀/▶, ENTER and RESET buttons. The buttons of the same name on the remote control and on the projector function equally.

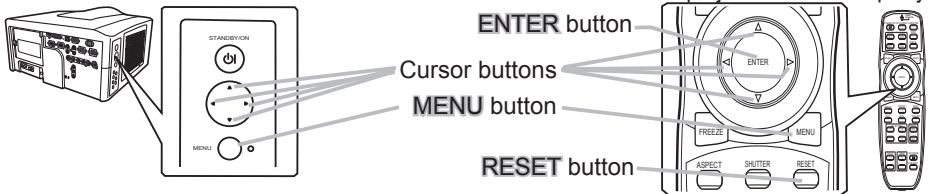

Start / finish the menu

To start the MENU, press the **MENU** button. The MENU you last used (EASY or ADVANCED) will appear. EASY MENU has priority to appear just after powered on. To finish the MENU, press the **MENU** button again. If you want to change it to EASY/ADVANCED MENU, select the EASY/ADVANCED MENU on the menu.

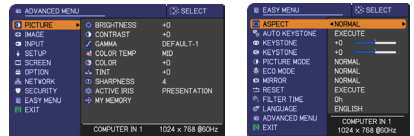

Indication in OSD (On Screen Display)

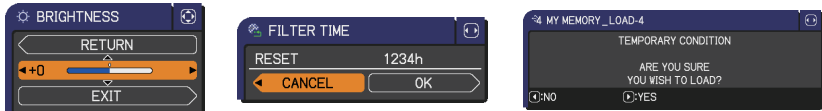

The meanings of the general words on the OSD are as follows.

Indication	Meaning
EXIT	Selecting this word finishes the OSD menu. It's the same as pressing the MENU button.
RETURN	Selecting this word returns the menu to the previous menu.
CANCEL or NO	Selecting this word cancels the operation in the present menu and returns to the previous menu.
OK or YES	Selecting this word executes the prepared function or shifts the menu to the next menu.

NOTE ● If you want to move the menu position, use the ▲/▼/◀/▶ buttons after pressing the **POSITION** button.





- Some functions cannot be performed when a certain input port is selected, or when a certain input signal is displayed.
- When you want to reset the operation, press the **RESET** button on the remote control during the operation. Note that items whose functions are performed simultaneously with operation (ex. LANGUAGE, H PHASE etc.) cannot be reset.
- Even if you do not do anything, the dialog will automatically disappear after about 30 seconds.

EASY MENU

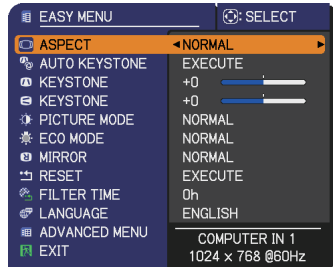
From the EASY MENU, items shown in the table below can be performed.

Select an item using the ▲/▼ cursor buttons on the projector or remote control. Then perform it according to the following table.



Item	Description																							
ASPECT	Using the ◀/▶ buttons switches the mode for aspect ratio. See the ASPECT item in IMAGE menu (📖34).																							
AUTO KEYSTONE	Using the ▶ button executes the auto keystone function. See the AUTO KEYSTONE item in SETUP menu (📖40).																							
 KEYSTONE	Using the ◀/▶ buttons corrects the vertical keystone distortion. See the  KEYSTONE item in SETUP menu (📖40).																							
 KEYSTONE	Using the ◀/▶ buttons corrects the horizontal keystone distortion. See the  KEYSTONE item in SETUP menu (📖41).																							
PICTURE MODE	Using the ◀/▶ buttons switches the picture mode. The picture modes are combinations of GAMMA and COLOR TEMP settings. Choose a suitable mode according to the projected source.																							
	<p>  </p> <table border="1"> <thead> <tr> <th></th> <th>COLOR TEMP</th> <th>GAMMA</th> </tr> </thead> <tbody> <tr> <td>NORMAL</td> <td>2 MID</td> <td>1 DEFAULT</td> </tr> <tr> <td>CINEMA</td> <td>3 LOW</td> <td>2 DEFAULT</td> </tr> <tr> <td>DYNAMIC</td> <td>1 HIGH</td> <td>3 DEFAULT</td> </tr> <tr> <td>BOARD(BLACK)</td> <td>4 Hi-BRIGHT-1</td> <td>4 DEFAULT</td> </tr> <tr> <td>BOARD(GREEN)</td> <td>5 Hi-BRIGHT-2</td> <td>4 DEFAULT</td> </tr> <tr> <td>WHITEBOARD</td> <td>2 MID</td> <td>5 DEFAULT</td> </tr> <tr> <td>DAYTIME</td> <td>6 Hi-BRIGHT-3</td> <td>6 DEFAULT</td> </tr> </tbody> </table>		COLOR TEMP	GAMMA	NORMAL	2 MID	1 DEFAULT	CINEMA	3 LOW	2 DEFAULT	DYNAMIC	1 HIGH	3 DEFAULT	BOARD(BLACK)	4 Hi-BRIGHT-1	4 DEFAULT	BOARD(GREEN)	5 Hi-BRIGHT-2	4 DEFAULT	WHITEBOARD	2 MID	5 DEFAULT	DAYTIME	6 Hi-BRIGHT-3
	COLOR TEMP	GAMMA																						
NORMAL	2 MID	1 DEFAULT																						
CINEMA	3 LOW	2 DEFAULT																						
DYNAMIC	1 HIGH	3 DEFAULT																						
BOARD(BLACK)	4 Hi-BRIGHT-1	4 DEFAULT																						
BOARD(GREEN)	5 Hi-BRIGHT-2	4 DEFAULT																						
WHITEBOARD	2 MID	5 DEFAULT																						
DAYTIME	6 Hi-BRIGHT-3	6 DEFAULT																						
	<ul style="list-style-type: none"> • When the combination of GAMMA and COLOR TEMP differs from pre-assigned modes above, the display on the menu for the PICTURE MODE is "CUSTOM". Please refer to the GAMMA and COLOR TEMP (📖31, 32) items in PICTURE menu. • When this function is performed, lines or other distortions may appear. 																							

(continued on next page)

EASY MENU

Item	Description
ECO MODE	Using the ◀/▶ buttons turns off/on the eco mode. See the ECO MODE item in SETUP menu (📖41).
MIRROR	Using the ◀/▶ buttons switches the mode for mirror status. See the MIRROR item in SETUP menu (📖41).
RESET	Performing this item resets all of the EASY MENU items except the FILTER TIME and LANGUAGE. A dialog is displayed for confirmation. Selecting the OK using the ▶ button performs resetting.
FILTER TIME	The usage time of the air filter is shown in the menu. Performing this item resets the filter time which counts usage time of the air filter. A dialog is displayed for confirmation. Selecting the OK using the ▶ button performs resetting. See the FILTER TIME item in OPTION menu (📖48).
LANGUAGE	Using the ◀/▶ buttons changes the display language. See the LANGUAGE item in SCREEN menu (📖42).
ADVANCED MENU	Press the ▶ or ENTER button to use the menu of PICTURE, IMAGE, INPUT, SETUP, SCREEN, OPTION, NETWORK or SECURITY.
EXIT	Press the ◀ or ENTER button to finish the OSD menu.

PICTURE menu

From the PICTURE menu, items shown in the table below can be performed.



Select an item using the ▲/▼ cursor buttons on the projector or remote control, and press the ► cursor button on the projector or remote control, or the **ENTER** button on the remote control to execute the item. Then perform it according to the following table.

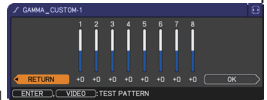

Item	Description
BRIGHTNESS	Using the ◀/▶ buttons adjusts the brightness. Dark ⇔ Light
CONTRAST	Using the ◀/▶ buttons adjusts the contrast. Weak ⇔ Strong
GAMMA	<p>Using the ▲/▼ buttons switches the gamma mode.</p> <p>1 DEFAULT ⇔ 1 CUSTOM ⇔ 2 DEFAULT ⇔ 2 CUSTOM ⇔ 3 DEFAULT ⇕ ⇕ 6 CUSTOM ⇔ 3 CUSTOM ⇕ ⇕ 6 DEFAULT ⇔ 5 CUSTOM ⇔ 5 DEFAULT ⇔ 4 CUSTOM ⇔ 4 DEFAULT</p> <p>To adjust CUSTOM</p> <p>Selecting a mode whose name includes CUSTOM and then pressing the ► button or the ENTER button displays a dialog to aid you in adjusting the mode.</p> <p>This function is useful when you want to change the brightness of particular tones.</p> <p>Choose an item using the ◀/▶ buttons, and adjust the level using the ▲/▼ buttons.</p> <p>You can display a test pattern for checking the effect of your adjustment by pressing the ENTER or VIDEO button. Each time you press the ENTER or VIDEO button, the pattern changes as below.</p> <p>No pattern ⇔ Gray scale of 9 steps ⇐</p> <p>↑ ⇐ Ramp ⇔ Gray scale of 15 steps</p> <p>The eight equalizing bars correspond to eight tone levels of the test pattern (Gray scale of 9 steps) except the darkest in the left end. If you want to adjust the 2nd tone from left end on the test pattern, use the equalizing adjustment bar "1". The darkest tone at the left end of the test pattern cannot be controlled with any of equalizing adjustment bar.</p> <ul style="list-style-type: none"> When this function is performed, lines or other distortions may appear.

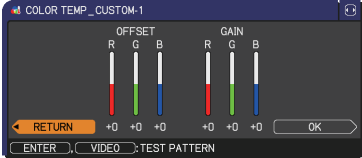

(continued on next page)

Item	Description
<p>COLOR TEMP</p>	<p>Using the ▲/▼ buttons switches the color temperature mode.</p> <p style="text-align: center;"> 1 HIGH ⇔ 1 CUSTOM ⇔ 2 MID ⇔ 2 CUSTOM ⇕ 6 CUSTOM 3 LOW ⇕ 6 HI-BRIGHT-3 3 CUSTOM ⇕ 5 CUSTOM ⇔ 5 HI-BRIGHT-2 ⇔ 4 CUSTOM ⇔ 4 HI-BRIGHT-1 </p> <p style="text-align: center;">To adjust CUSTOM</p> <p>Selecting a mode whose name includes CUSTOM and then pressing the ► button or the ENTER button displays a dialog to aid you in adjusting the OFFSET and GAIN of the selected mode.</p>  <p>OFFSET adjustments change the color intensity on the whole tones of the test pattern. GAIN adjustments mainly affect color intensity on the brighter tones of the test pattern.</p> <p>Choose an item using the ◀/▶ buttons, and adjust the level using the ▲/▼ buttons.</p> <p>You can display a test pattern for checking the effect of your adjustment by pressing the ENTER or VIDEO button.</p> <p>Each time you press the ENTER or VIDEO button, the pattern changes as below.</p> <p>No pattern ⇔ Gray scale of 9 steps ⇐↷ ⇕ Ramp ⇔ Gray scale of 15 steps</p> <ul style="list-style-type: none"> • When this function is performed, lines or other distortion may appear. 
<p>COLOR</p>	<p>Using the ◀/▶ buttons adjusts the strength of whole color. Weak ⇔ Strong</p> <ul style="list-style-type: none"> • This item can be selected not only for a video, s-video and component signal but also HDMI and DVI-D signal when the VIDEO is selected on the DIGITAL FORMAT item (Ⓜ37).
<p>TINT</p>	<p>Using the ◀/▶ buttons adjusts the tint. Reddish ⇔ Greenish</p> <ul style="list-style-type: none"> • This item can be selected not only for a video, s-video and component signal but also HDMI and DVI-D signal when the VIDEO is selected on the DIGITAL FORMAT item (Ⓜ37).
<p>SHARPNESS</p>	<p>Using the ◀/▶ buttons adjusts the sharpness. Weak ⇔ Strong</p> <ul style="list-style-type: none"> • There may be some noise and/or the screen may flicker for a moment when an adjustment is made. This is not a malfunction.

(continued on next page)



Item	Description								
<p>ACTIVE IRIS</p>	<p>Using the ▲/▼ cursor buttons changes the active iris control mode. PRESENTATION ⇄ THEATER ⇄ MANUAL</p>  <table border="1" data-bbox="318 296 1014 485"> <thead> <tr> <th></th> <th>Feature</th> </tr> </thead> <tbody> <tr> <td>PRESENTATION</td> <td>The active iris displays the best presentation image for both bright and dark scenes.</td> </tr> <tr> <td>THEATER</td> <td>The active iris displays the best theater image for both bright and dark scenes.</td> </tr> <tr> <td>MANUAL</td> <td>The active iris is set to fixed brightness (0:dark - 7:bright)</td> </tr> </tbody> </table> <ul style="list-style-type: none"> • The screen may flicker when the PRESENTATION or THEATER modes are selected. If this occurs select MANUAL. 		Feature	PRESENTATION	The active iris displays the best presentation image for both bright and dark scenes.	THEATER	The active iris displays the best theater image for both bright and dark scenes.	MANUAL	The active iris is set to fixed brightness (0:dark - 7:bright)
	Feature								
PRESENTATION	The active iris displays the best presentation image for both bright and dark scenes.								
THEATER	The active iris displays the best theater image for both bright and dark scenes.								
MANUAL	The active iris is set to fixed brightness (0:dark - 7:bright)								
<p>MY MEMORY</p>	<p>This projector has 4 memories for adjustment data (for all the items of the PICTURE menu). Selecting a function using the ▲/▼ buttons and pressing the ► or ENTER button performs each function.</p>  <ul style="list-style-type: none"> • This item can be selected not only for a video, s-video and component signal but also HDMI and DVI-D signal when the VIDEO is selected on the DIGITAL FORMAT item. <p><u>SAVE-1, SAVE-2, SAVE-3, SAVE-4</u></p> <p>Performing a SAVE function saves the current adjustment data into the memory linked in the number included in the function's name.</p> <ul style="list-style-type: none"> • Remember that the current data being stored of a memory will be lost by saving new data into the memory. <p><u>LOAD-1, LOAD-2, LOAD-3, LOAD-4</u></p> <p>Performing a LOAD function loads the data from the memory linked in the number included in the function's name, and adjusts the picture automatically depending on the data.</p> <ul style="list-style-type: none"> • The LOAD functions whose linked memory has no data are skipped. • Remember that the current adjusted condition will be lost by loading data. If you want to keep the current adjustment, please save it before performing a LOAD function. • There may be some noise and the screen may flicker for a moment when loading data. This is not malfunction. • The LOAD functions can be also performed by the MY MEMORY button which can be set by the MY BUTTON item in OPTION menu (49). 								

IMAGE menu

From the IMAGE menu, items shown in the table below can be performed.

Select an item using the ▲/▼ cursor buttons on the projector or remote control, and press the ► cursor button on the projector or remote control, or ENTER button on the remote control to execute the item.

Then perform it according to the following table.

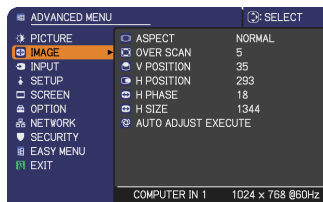

Item	Description
ASPECT	<p>Using the ▲/▼ buttons switches the mode for aspect ratio.</p> <p>For a COMPUTER signal NORMAL ⇄ 4:3 ⇄ 16:9 ⇄ 16:10* ⇄ SMALL* ⇄ NATIVE* ⇄ FULL*</p> <p>For an HDMI or DVI-D signal NORMAL ⇄ 4:3 ⇄ 16:9 ⇄ 16:10* ⇄ 14:9 ⇄ SMALL* ⇄ NATIVE* ⇄ FULL*</p> <p>For a Video signal, S-video signal or component video signal 4:3 ⇄ 16:9 ⇄ 16:10* ⇄ 14:9 ⇄ SMALL* ⇄ NATIVE* ⇄ FULL*</p> <p>For no signal 4:3 (fixed, except CP-WX11000) / FULL (fixed, CP-WX11000)</p> <ul style="list-style-type: none"> • *16:10 / FULL: CP-WX11000 only. NATIVE: Except CP-X10000. SMALL: Except CP-WX11000. • The NORMAL mode keeps the original aspect ratio of the signal.
OVER SCAN	<p>Using the ◀/▶ buttons adjusts the over-scan ratio.</p> <p>Small (It magnifies picture) ⇄ Large (It reduces picture)</p> <ul style="list-style-type: none"> • This item can be selected not only for a video, s-video and component signal but also HDMI and DVI-D signal when the VIDEO is selected on the DIGITAL FORMAT item (p.37). • When this adjustment is too large, certain degradation may appear at the frame area of the picture. In such a case, please adjust small.
V POSITION	<p>Using the ◀/▶ buttons adjusts the vertical position.</p> <p>Down ⇄ Up</p> <ul style="list-style-type: none"> • Over-adjusting the vertical position may cause noise to appear on the screen. If this occurs, please reset the vertical position to the default setting. Pressing the RESET button when the V POSITION is selected will reset the V POSITION to the default setting. • When this function is performed on a video signal, s-video signal, or component video signal of 480i@60 or 576i@50 input the range of this adjustment depends on the OVER SCAN (p.37) setting. It is not possible to adjust when the OVER SCAN is set to 10. • This item cannot be selected for an HDMI or DVI-D signal.
H POSITION	<p>Using the ◀/▶ buttons adjusts the horizontal position.</p> <p>Right ⇄ Left</p> <ul style="list-style-type: none"> • Over-adjusting the horizontal position may cause noise to appear on the screen. If this occurs, please reset the horizontal position to the default setting. Pressing the RESET button when the H POSITION is selected will reset the H POSITION to the default setting. • When this function is performed on a video signal, s-video signal, or component video signal of 480i@60 or 576i@50 input the range of this adjustment depends on the OVER SCAN (p.37) setting. It is not possible to adjust when the OVER SCAN is set to 10. • This item cannot be selected for an HDMI or DVI-D signal.

Item	Description
H PHASE	<p>Using the ◀/▶ buttons adjusts the horizontal phase to eliminate flicker. Right ⇔ Left</p> <ul style="list-style-type: none"> • This item can be selected only for a computer signal or a component video signal. (except 480i@60, 576i@50, SCART RGB input.)
H SIZE	<p>Using the ◀/▶ buttons adjusts the horizontal size. Small ⇔ Large</p> <ul style="list-style-type: none"> • This item can be selected only for a computer signal. • When this adjustment is excessive, the picture may not be displayed correctly. In such a case, please reset the adjustment by pressing the RESET button on the remote control during this operation.
AUTO ADJUST EXECUTE	<p>Selecting this item performs the automatic adjustment feature.</p> <p>For a computer signal The vertical position, the horizontal position and the horizontal phase will be automatically adjusted. Make sure that the application window is set to its maximum size prior to attempting to use this feature. A dark picture may still be incorrectly adjusted. Use a bright picture when adjusting.</p> <p>For a video signal and s-video signal The video format best suited for the respective input signal will be selected automatically. This function is available only when the AUTO is selected for the VIDEO FORMAT item in the INPUT menu (📺37). The vertical position and horizontal position will be automatically set to the default.</p> <p>For a component video signal The vertical position, horizontal position and horizontal phase will be automatically set to the default.</p> <ul style="list-style-type: none"> • The automatic adjustment operation requires approx. 10 seconds. Also please note that it may not function correctly with some input. When this function is performed for a video signal, a certain extra such as a line may appear outside a picture. • The items adjusted by this function may vary when the FINE or DISABLE is selected for the AUTO ADJUST item of the SERVICE item in the OPTION menu (📺50).

INPUT menu

From the INPUT menu, items shown in the table below can be performed.

Select an item using the ▲/▼ cursor buttons on the projector or remote control, and press the ► cursor button on the projector or remote control, or **ENTER** button on the remote control to execute the item.

Then perform it according to the following table.

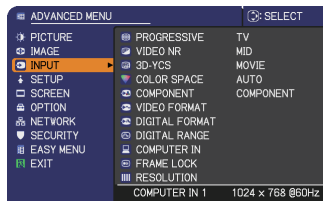

Item	Description
PROGRESSIVE	<p>Using the ▲/▼ buttons switches the progress mode. TV ⇄ FILM ⇄ OFF ↑—————↑</p> <ul style="list-style-type: none"> This function is performed only for an interlaced signal at the VIDEO 1, VIDEO 2 or S-VIDEO input, and for 480i@60, 576i@50 or 1080i@50/60 signal at the Component, HDMI or DVI-D input. When TV or FILM is selected, the screen image will be sharp. FILM adapts to the 2-3 Pull-Down conversion system. But these may cause a certain defect (for example, jagged line) of the picture for a quick moving object. In such a case, please select OFF, even though the screen image may lose sharpness.
VIDEO NR	<p>Using the ▲/▼ buttons switches the noise reduction mode. HIGH ⇄ MID ⇄ LOW ↑—————↑</p> <ul style="list-style-type: none"> This function is performed only for the VIDEO 1, VIDEO 2 or S-VIDEO input, and for 480i@60, 576i@50 or 1080i@50/60 signal at the Component, HDMI or DVI-D input. When this function is excessive, it may cause a certain degradation of the picture.
3D-YCS	<p>Using the ▲/▼ buttons switches the 3D-YCS mode. STILL ⇄ MOVIE ⇄ OFF ↑—————↑</p> <ul style="list-style-type: none"> This function performs only at a VIDEO 1 or VIDEO 2 input of NTSC, and PAL. MOVIE is the mode for images with a lot of motions like movies, and STILL is the mode for images with few motions or completely still ones like slides.
COLOR SPACE	<p>Using the ▲/▼ buttons switches the mode for color space. AUTO ⇄ RGB ⇄ SMPTE240 ⇄ REC709 ⇄ REC601 ↑—————↑</p> <ul style="list-style-type: none"> This item can be selected only for an RGB signal or a component video signal (except 480i@60, 576i@50 and SCART RGB). The AUTO mode automatically selects the optimum mode. The AUTO operation may not work well at some signals. In such a case, it might be good to select a suitable mode except AUTO.

(continued on next page)

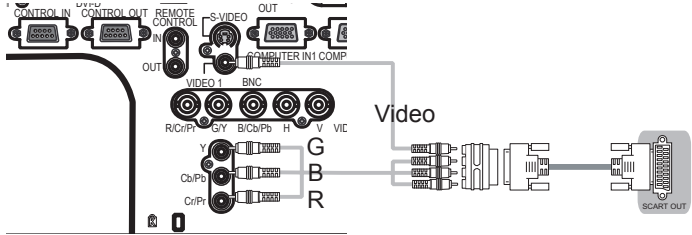
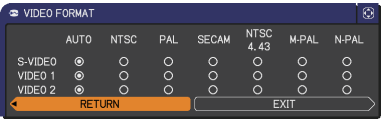

Item	Description								
<p>COMPONENT</p>	<p>Using the ▲/▼ buttons switches the function of the Component (Y, Cb/Pb, Cr/Pr) port.</p> <p>COMPONENT ⇔ SCART RGB</p> <p>When the SCART RGB is selected, the Component (Y, Cb/Pb, Cr/Pr) and VIDEO 1 ports will function as a SCART RGB port. A SCART adapter or SCART cable is required for a SCART RGB input to the projector. For details, contact your dealer.</p> 								
<p>VIDEO FORMAT</p>	<p>Set the video format for the S-VIDEO, VIDEO 1 port and VIDEO 2 port.</p> <p>(1) Use the ▲/▼ buttons to select the input port.</p> <p>(2) Using the ◀/▶ buttons switches the mode for video format.</p> <p>AUTO ⇔ NTSC ⇔ PAL ⇔ SECAM ↕ N-PAL ⇔ M-PAL ⇔ NTSC4.43 ↕</p>  <ul style="list-style-type: none"> • This item is performed only for a video signal from the VIDEO 1, VIDEO 2 port or the S-VIDEO port. • The AUTO mode automatically selects the optimum mode. • The AUTO operation may not work well for some signals. If the picture becomes unstable (e.g. an irregular picture, lack of color), please select the mode according to the input signal. 								
<p>DIGITAL FORMAT</p>	<p>Set the video format for the HDMI port and DVI-D port.</p> <p>(1) Use the ▲/▼ buttons to select the input port.</p> <p>(2) Using the ◀/▶ buttons switches the format of digital format.</p> <p>AUTO ⇔ VIDEO ⇔ COMPUTER</p> <table border="1" data-bbox="319 1300 1013 1412"> <thead> <tr> <th></th> <th>Feature</th> </tr> </thead> <tbody> <tr> <td>AUTO</td> <td>Selecting the optimum mode automatically.</td> </tr> <tr> <td>VIDEO</td> <td>Suitable for DVD signals</td> </tr> <tr> <td>COMPUTER</td> <td>Suitable for computer signals</td> </tr> </tbody> </table> <ul style="list-style-type: none"> • If the COMPUTER is selected, COLOR, TINT, OVERSCAN can not be selected. 		Feature	AUTO	Selecting the optimum mode automatically.	VIDEO	Suitable for DVD signals	COMPUTER	Suitable for computer signals
	Feature								
AUTO	Selecting the optimum mode automatically.								
VIDEO	Suitable for DVD signals								
COMPUTER	Suitable for computer signals								

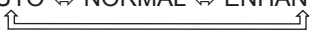
(continued on next page)

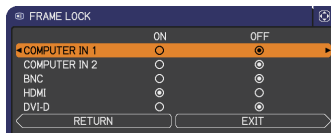
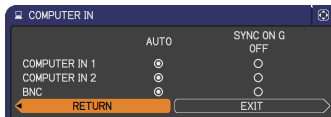
Item	Description								
<p>DIGITAL RANGE</p>	<p>Set the digital range for HDMI port and DVI-D port.</p> <p>(1) Use the ▲/▼ buttons to select the input port.</p> <p>(2) Using the ◀/▶ cursor buttons changes the digital signal mode.</p> <p>AUTO ↔ NORMAL ↔ ENHANCED</p>  <table border="1" data-bbox="318 381 1014 499"> <thead> <tr> <th></th> <th>Feature</th> </tr> </thead> <tbody> <tr> <td>AUTO</td> <td>Selecting the optimum mode automatically.</td> </tr> <tr> <td>NORMAL</td> <td>Suitable for DVD signals (16-235)</td> </tr> <tr> <td>ENHANCED</td> <td>Suitable for computer signals (0-255)</td> </tr> </tbody> </table> <ul style="list-style-type: none"> • If the contrast of the screen image is too strong or too weak, try finding a more suitable mode. 		Feature	AUTO	Selecting the optimum mode automatically.	NORMAL	Suitable for DVD signals (16-235)	ENHANCED	Suitable for computer signals (0-255)
	Feature								
AUTO	Selecting the optimum mode automatically.								
NORMAL	Suitable for DVD signals (16-235)								
ENHANCED	Suitable for computer signals (0-255)								
<p>COMPUTER IN</p>	<p>Set the computer input signal type for the COMPUTER IN port.</p> <p>(1) Use the ▲/▼ buttons to select the COMPUTER IN port to be set.</p> <p>(2) Use the ◀/▶ buttons to select the computer input signal type.</p> <ul style="list-style-type: none"> • Selecting the AUTO mode allows you to input a sync on G signal or component signal from the port. • In the AUTO mode, the picture may be distorted with certain input signals. In such a case, remove the signal connector so that no signal is received and select the SYNC ON G OFF, and then reconnect the signal. 								
<p>FRAME LOCK</p>	<p>Set the frame lock function on/off for each port.</p> <p>(1) Use the ▲/▼ buttons to select the input ports.</p> <p>(2) Use the ◀/▶ buttons to turn the frame lock function on/off .</p> <p>ON ↔ OFF</p> <ul style="list-style-type: none"> • This item can be performed only on a signal with a vertical frequency of 50 to 60 Hz. • When ON is selected, moving pictures are displayed more smoothly. • This function may cause a certain degradation of the picture. In such a case, please select OFF. 								



(continued on next page)

Item	Description
<p>RESOLUTION</p>	<p>The resolution for the COMPUTER IN1, COMPUTER IN2 and BNC input signals can be set on this projector.</p> <p>In the RESOLUTION menu select the resolution you wish to display using the ▲/▼ buttons.</p> <p>■AUTO Selecting AUTO will set a resolution appropriate to the input signal.</p> <p>■STANDARD Pressing the ▶ or ENTER button when selecting a STANDARD resolution will automatically adjust the horizontal and vertical positions, clock phase and horizontal size. The INPUT-INFORMATION- dialog () will be displayed.</p> <p>■CUSTOM (1) To set a custom resolution use the ▲/▼ buttons to select the CUSTOM and the CUSTOM RESOLUTION BOX will be displayed. Set the horizontal (HORZ) and vertical (VERT) resolutions using the ▲/▼/◀/▶ buttons. This function is may not support all resolutions.</p> <p>(2) To save the setting place the cursor on the right-most digit and press the ▶ button. The horizontal and vertical positions, clock phase and horizontal size will be automatically adjusted. After the INPUT-INFORMATION- dialog () has displayed for about 3 seconds the screen will return to the RESOLUTION menu displaying the changed resolution.</p> <p>To revert back to the previous resolution without saving changes place the cursor on the left-most digit and press the ◀ button. The screen will then return to the RESOLUTION menu displaying the previous resolution.</p> <ul style="list-style-type: none"> • For some pictures, this function may not work well.

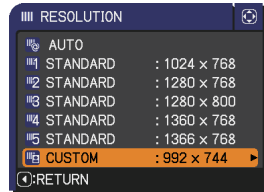
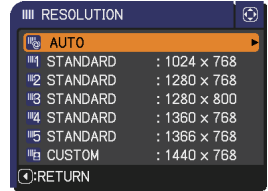

SETUP menu

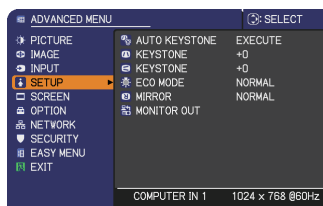

From the SETUP menu, items shown in the table below can be performed.

Select an item using the ▲/▼ cursor buttons on the projector or remote control, and press the ► cursor button on the projector or remote control, or the **ENTER** button on the remote control to execute the item. Then perform it according to the following table.



Item	Description
<p style="text-align: center;">AUTO KEYSTONE</p>	<p>Selecting this item performs the Automatic keystone distortion correction. Projector automatically corrects vertical keystone distortion due to the (forward/backward) setup angle by itself.</p> <p>This function will be executed only once when selected in the menu. When the slant of the projector is changed, execute this function again.</p> <ul style="list-style-type: none"> • The adjustable range of this function will vary among inputs. For some input, this function may not work well. • When V:INVERT or H&V:INVERT is selected to the MIRROR item in the SETUP menu, if the projector screen is inclined or angled downward, this function may not work correctly. • When the zoom adjustment is set to the TELE (telephoto focus), this function may be excessive. This function should be used when the zoom adjustment is set to the full WIDE (wide-angle focus) whenever possible. • When the projector is placed on the level (about $\pm 3^\circ$), this function may not work. • When the vertical lens shift is not set fully upward (not set fully downward for the optional lens type USL-801 only (51)), this function may not work well. • When the horizontal lens shift is not set to the center, this function may not work well. • This function will be unavailable when the Transition Detector is on (64).
<p> KEYSTONE</p>	<p>Using the ◀/▶ buttons corrects the vertical keystone distortion.</p> <p style="text-align: center;">Shrink the bottom of the image ⇔ Shrink the top of the image</p> <ul style="list-style-type: none"> • The adjustable range of this function will vary among inputs. For some input, this function may not work well. • When the horizontal lens shift is not set to the center, this function may not work well. • This function will be unavailable when the Transition Detector is on (64).

(continued on next page)

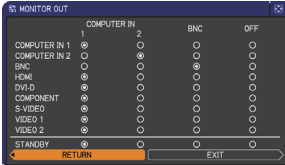
Item	Description
 KEYSTONE	<p>Using the ◀/▶ buttons corrects the horizontal keystone distortion.</p> <p>Shrink the left of the image ⇔ Shrink the right of the image</p> <ul style="list-style-type: none"> • The adjustable range of this function will vary among inputs. For some input, this function may not work well. • When the zoom adjustment is set to the TELE (telephoto focus), this function may be excessive. This function should be used when the zoom adjustment is set to the full WIDE (wide-angle focus) whenever possible. • When the vertical lens shift is not set fully upward (not set fully downward for the optional lens type USL-801 only (p.51), this function may not work well. • This function will be unavailable when the Transition Detector is on (p.64).
<p>ECO MODE</p>	<p>Using the ▲/▼ buttons turns off/on the eco mode.</p> <p>NORMAL ⇔ ECO</p> <ul style="list-style-type: none"> • When the ECO is selected, acoustic noise and screen brightness are reduced.
<p>MIRROR</p>	<p>Using the ▲/▼ buttons switches the mode for mirror status.</p> <div style="text-align: center;">  <p>NORMAL ⇔ H:INVERT ⇔ V:INVERT ⇔ H&V:INVERT</p> <p>↑ _____ ↑</p> </div> <p>If the Transition Detector is on and MIRROR status is changed, Transition Detector alarm (p.64) will be displayed when projector is restarted after the power switch is turned off.</p> <ul style="list-style-type: none"> • When V:INVERT or H&V:INVERT is selected, functions of ▲/▼ cursor buttons on the projector are reversed after the dialog menu disappears.
<p>MONITOR OUT</p>	<p>The combination of a picture shown on screen and output from the MONITOR OUT port can be arranged in the menu.</p> <p>The picture coming into the port selected in the (2) is output to the MONITOR OUT port while an image from the port chosen in the (1) is on screen.</p> <p>(1) Choose a picture input port using ▲/▼ buttons.</p> <p>• Choose STANDBY, to select the output signal from the MONITOR OUT port in the standby mode.</p> <p>(2) Select one of the COPUTER IN or BNC ports using ◀/▶ buttons.</p> <p>COMPUTER IN1 ⇔ COMPUTER IN2 ⇔ OFF ⇔ BNC ⇔</p> <ul style="list-style-type: none"> • OFF disables the MONITOR OUT port. 

SCREEN menu

From the SCREEN menu, items shown in the table below can be performed.

Select an item using the ▲/▼ cursor buttons on the projector or remote control, and press the ► cursor button on the projector or remote control, or **ENTER** button on the remote control to execute the item.

Then perform it according to the following table.

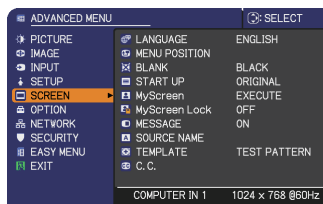



Item	Description								
LANGUAGE	<p>Using the ▲/▼/◀/▶ buttons switches the OSD (On Screen Display) language.</p>								
MENU POSITION	<p>Using the ▲/▼/◀/▶ buttons adjusts the menu position. To quit the operation, press the MENU button on the remote control or keep no operation for about 10 seconds.</p>								
BLANK	<p>Using the ▲/▼ buttons switches the mode for the blank screen. The blank screen is a screen for the temporarily blanking feature (26). It is displayed by pressing the BLANK button on the remote control.</p> <p>MyScreen ⇄ ORIGINAL ⇄ BLUE ⇄ WHITE ⇄ BLACK</p> <table border="1"> <thead> <tr> <th></th> <th>Feature</th> </tr> </thead> <tbody> <tr> <td>MyScreen</td> <td>Screen can be registered by the MyScreen item (44).</td> </tr> <tr> <td>ORIGINAL</td> <td>Screen preset as the standard screen.</td> </tr> <tr> <td>BLUE, WHITE, BLACK</td> <td>Plain screens in each color.</td> </tr> </tbody> </table> <ul style="list-style-type: none"> To avoid remaining as an afterimage, the MyScreen or ORIGINAL screen will change to the plain black screen after several minutes. 		Feature	MyScreen	Screen can be registered by the MyScreen item (44).	ORIGINAL	Screen preset as the standard screen.	BLUE, WHITE, BLACK	Plain screens in each color.
	Feature								
MyScreen	Screen can be registered by the MyScreen item (44).								
ORIGINAL	Screen preset as the standard screen.								
BLUE, WHITE, BLACK	Plain screens in each color.								



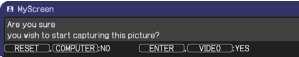

(continued on next page)

Item	Description								
START UP	<p>Using the ▲/▼ buttons switches the mode for the start-up screen. The start-up screen is a screen displayed when no signal or an unsuitable signal is detected.</p> <p style="text-align: center;">MyScreen ⇄ ORIGINAL ⇄ OFF</p> <p style="text-align: center;">↑—————↑</p>								
	<table border="1" style="width: 100%;"> <thead> <tr> <th style="width: 50%;"></th> <th style="width: 50%;">Feature</th> </tr> </thead> <tbody> <tr> <td data-bbox="318 363 535 416">MyScreen</td> <td data-bbox="535 363 1016 416">Screen can be registered by the MyScreen item (📖44).</td> </tr> <tr> <td data-bbox="318 416 535 448">ORIGINAL</td> <td data-bbox="535 416 1016 448">Screen preset as the standard screen.</td> </tr> <tr> <td data-bbox="318 448 535 480">OFF</td> <td data-bbox="535 448 1016 480">Plain black screen.</td> </tr> </tbody> </table>		Feature	MyScreen	Screen can be registered by the MyScreen item (📖44).	ORIGINAL	Screen preset as the standard screen.	OFF	Plain black screen.
		Feature							
	MyScreen	Screen can be registered by the MyScreen item (📖44).							
	ORIGINAL	Screen preset as the standard screen.							
OFF	Plain black screen.								
<ul style="list-style-type: none"> • To avoid remaining as an afterimage, the MyScreen or ORIGINAL screen will change to the BLANK screen (📖26) after several minutes. If also the BLANK screen is the MyScreen or ORIGINAL, the plain black screen is instead used. • When the ON is selected to the MyScreen PASSWORD item in the SECURITY menu (📖62), the START UP is fixed to MyScreen. 									

(continued on next page)

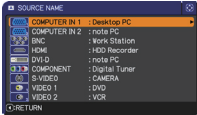
Item	Description
<p>MyScreen</p>	<p>This item allows you to capture an image for use as a MyScreen image which can be used as the BLANK screen and START UP screen. Display the image you want to capture before executing the following procedure.</p> <ol style="list-style-type: none"> 1. Selecting this item displays a dialog titled "MyScreen". It will ask you if you start capturing an image from the current screen.  <p>Please wait for the target image to be displayed, and press the ENTER or VIDEO button when the image is displayed. The image will freeze and the frame for capturing will appear.</p> <p>To stop performing, press the RESET or COMPUTER button on the remote control.</p> 2. Using the ▲/▼/◀/▶ buttons adjusts the frame position.  <p>Please move the frame to the position of the image which you want to use. The frame may not be able to be moved for some input signals.</p> <p>To start registration, press the ENTER or VIDEO button on the remote control.</p>  <p>To restore the screen and return to the previous dialog, press the RESET or COMPUTER button on the remote control.</p> <p>Registration takes several minutes.</p> <p>When the registration is completed, the registered screen and the following message is displayed for several seconds:</p> <p>"MyScreen registration is finished."</p> <p>If the registration failed, the following message is displayed:</p> <p>"A capturing error has occurred. Please try again."</p> <ul style="list-style-type: none"> • This item cannot be selected for an HDMI or a DVI-D signal. • This function cannot be selected when the ON is selected to the MyScreen Lock item (see below). • This function cannot be selected when the ON is selected to the MyScreen PASSWORD item in SECURITY menu (see 62).
<p>MyScreen Lock</p>	<p>Using the ▲/▼ buttons turns on/off the MyScreen lock function.</p> <p>ON ⇔ OFF</p> <p>When the ON is selected, the item MyScreen is locked. Use this function for protecting the current MyScreen.</p> <ul style="list-style-type: none"> • This function cannot be selected when the ON is selected to the MyScreen PASSWORD item in SECURITY menu (see 62).

(continued on next page)

Item	Description
MESSAGE	<p>Using the ▲/▼ buttons turns on/off the message function. ON ⇔ OFF</p> <p>When the ON is selected, the following message function works. “AUTO IN PROGRESS” while automatically adjusting “NO INPUT IS DETECTED” “SYNC IS OUT OF RANGE” “INVALID SCAN FREQ” “Searching....” while searching for the input “Detecting....” while an input signal is detected The indication of the input signal displayed by changing The indication of the aspect ratio displayed by changing The indication of the PICTURE MODE displayed by changing The indication of the ACTIVE IRIS displayed by changing The indication of the MY MEMORY displayed by changing The indication of “FREEZE” and “II” while freezing the screen by pressing the FREEZE button.</p> <ul style="list-style-type: none"> • When the OFF is selected, please remember if the picture is frozen. Do not mistake freezing for a malfunction (25).
SOURCE NAME	<p>Each input port for this projector can have a name applied to it.</p> <p>(1) Use the ▲/▼ buttons on the SCREEN menu to select SOURCE NAME and press the ► button. The SOURCE NAME menu will be displayed.</p> <p>(2) Use the ▲/▼ buttons on the SOURCE NAME menu to select the port to be named and press the ► button. Right side of the menu is blank until a name is specified. The SOURCE NAME dialog will be displayed.</p> <p>(3) The current name will be displayed on the first line. Use the ▲/▼/◀/▶ buttons and the ENTER or VIDEO button to select and enter characters. The RESET button can be used to erase 1 character at a time. Also if you move the cursor to DELETE or ALL CLEAR on screen and push the ENTER or VIDEO button, 1 character or all characters will be erased. The name can be a maximum of 16 characters.</p> <p>(4) To change an already inserted character, press the ▲ button to move the cursor to the first line, and use the ◀/▶ buttons to move the cursor on the character to be changed. After pressing the ENTER or VIDEO button, the character is selected. Then, follow the same procedure as described at the item (3) above.</p> <p>(5) To finish entering text, move the cursor to the OK on screen and press the ENTER or VIDEO button. To revert to the previous name without saving changes, move the cursor to the CANCEL on screen and press the ENTER or VIDEO button.</p>    

(continued on next page)

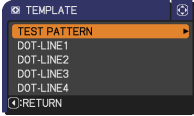
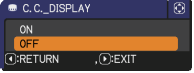
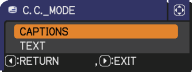
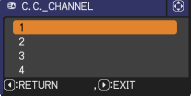
Item	Description
<p>TEMPLATE</p>	<p>Using the ▲/▼ buttons switches the mode for the template screen. Press the ► button to display the selected template, and press the ◀ button to close the displayed screen.</p> <p>The last selected template is displayed when the MY BUTTON allocated to the TEMPLATE function is pressed (📺49).</p> <p>↵ TEST PATTERN ⇄ DOT-LINE1 ⇄ DOT-LINE4 ⇄ DOT-LINE3 ⇄ DOT-LINE2</p> 
<p>C.C. (Closed Caption)</p>	<p>The C.C. is the function that displays a transcript or dialog of the audio portion of a video, files or other presentation or other relevant sounds. It is required to have NTSC format video or 480i@60 format component video source supporting C.C. feature to utilize this function. It may not work properly, depending on equipment or signal source. In this case, please turn off the Closed Caption.</p> <p>DISPLAY Select Closed Caption DISPLAY setting from following options using ▲/▼ buttons.</p> <p>OFF ⇄ ON</p> <p>OFF: Closed Caption is off ON: Closed Caption is on</p> <ul style="list-style-type: none"> • The caption is not displayed when the OSD menu is active. • The Closed Caption is the function to display the dialogue, narration, and / or sound effects of a television program or other video sources. The Closed Caption availability is depending upon broadcaster and/or content. <p>MODE Select Closed Caption MODE setting from following options using ▲/▼ buttons.</p> <p>CAPTIONS ⇄ TEXT</p> <p>CAPTIONS: Display Closed Caption TEXT: Display Text data, which is for additional information such as news reports or a TV program guide. The information covers the entire screen. Not all of the C.C. program has Text information.</p> <p>CHANNEL Select Closed Caption CHANNEL from following options using ▲/▼ buttons.</p> <p>1 ⇄ 2 ⇄ 3 ⇄ 4</p> <p>↑ ↵ ↵ ↵ ↵</p> <p>1: Channel 1, primary channel / language 2: Channel 2 3: Channel 3 4: Channel 4</p> <p>The channel data may vary, depending on the content. Some channel might be used for secondary language or empty.</p>   

OPTION menu

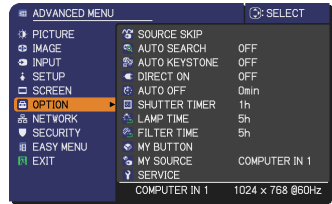

From the OPTION menu, items shown in the table below can be performed.

Select an item using the ▲/▼ cursor buttons on the projector or remote control, and press the ► cursor button on the projector or remote control, or ENTER button on the remote control to execute the item, except for the items LAMP TIME and FILTER TIME. Then perform it according to the following table.



Item	Description
SOURCE SKIP	<p>The port that is set to the "SKIP" is ignored in searching by the AUTO SEARCH function ((p. 22)) or the buttons of COMPUTER, VIDEO, or DIGITAL ((p. 22)).</p> <p>(1) Choose a picture input port using ▲/▼ buttons. (2) Using the ◀/▶ buttons turns on/off the SOURCE SKIP function. NORMAL ⇄ SKIP</p> <ul style="list-style-type: none"> • This setting of "SKIP" is not available when specifying one certain input port by MY SOURCE button etc.
AUTO SEARCH	<p>Using the ▲/▼ buttons turns on/off the automatic signal search function. ON ⇄ OFF</p> <p>When the ON is selected, detecting no signal automatically cycles through input ports in the following order. The search is started from the current port. Then when an input is found, the projector will stop searching and display the image.</p> <p>COMPUTER IN1 ⇄ COMPUTER IN2 ⇄ BNC ⇄ HDMI ⇄ DVI-D ⇄ VIDEO 2 ⇄ VIDEO 1 ⇄ S-VIDEO ⇄ COMPONENT</p> <ul style="list-style-type: none"> • The port that is set to the "SKIP" is ignored in searching by the AUTO SEARCH function ((p. 22)).
AUTO KEYSTONE	<p>Using the ▲/▼ buttons turns on/off the automatic keystone function. ON ⇄ OFF</p> <p>ON : Automatic keystone distortion correction will be executed whenever changing the slant of the projector. OFF : This function is disabled. Please execute the AUTO KEYSTONE in the SETUP menu for automatic keystone distortion correction.</p> <ul style="list-style-type: none"> • When the projector is suspended from the ceiling this feature will not function properly so select the OFF. • This function will be unavailable when the Transition Detector is on ((p. 22)).

(continued on next page)

Item	Description
<p>DIRECT ON</p>	<p>Using the ▲/▼ buttons turns on/off the DIRECT ON function. ON ⇔ OFF</p> <p>When set to the ON, the lamp in projector will be automatically turned on without the usual procedure (📖19), only when the projector is supplied with the power after the power was cut while the lamp was on.</p> <ul style="list-style-type: none"> • This function does not work as long as the power has been supplied to the projector while the lamp is off. • After turning the lamp on by the DIRECT ON function, if neither input nor operation is detected for about 30 minutes, the projector is turned off, even though the AUTO OFF function (📖below) is disabled.
<p>AUTO OFF</p>	<p>Using the ▲/▼ buttons adjusts the time to count down to automatically turn the projector off. Long (max. 99 minutes) ⇔ Short (min. 0 minute = DISABLE)</p> <div style="display: flex; justify-content: space-around; align-items: center;">   </div> <p>When the time is set to 0, the projector is not turned off automatically. When the time is set to 1 to 99, and when the passed time with no-signal or an unsuitable signal reaches at the set time, the projector lamp will be turned off.</p> <p>If one of the projector's buttons or the remote control buttons is pressed or one of the commands (except get commands) is transmitted to the CONTROL port during the corresponding time, projector will not be turned off.</p> <p>Please refer to the section "Turning off" (📖20).</p>
<p>SHUTTER TIMER</p>	<p>Using the ▲/▼ buttons adjusts the time with shutter closed to count down to automatically turn the projector off. 1h ⇔ 3h ⇔ 6h</p>  <ul style="list-style-type: none"> • The shutter will open automatically when turning the projector on again.
<p>LAMP TIME</p>	<p>The lamp time is the usage time of the lamp, counted after the last resetting. It is shown in the OPTION menu.</p> <p>Pressing the RESET button on the remote control or the ► button of the projector displays a dialog.</p> <p>To reset the lamp time, select the OK using the ► button. CANCEL ⇔ OK</p> <ul style="list-style-type: none"> • Please reset the lamp time only when you have replaced the lamp, for a suitable indication about the lamp. • For the lamp replacement, see the section "Lamp unit" (📖67, 68).
<p>FILTER TIME</p>	<p>The filter time is the usage time of the air filter, counted after the last resetting. It is shown in the OPTION menu.</p> <p>Pressing the RESET button on the remote control or the ► button of the projector displays a dialog.</p> <p>To reset the filter time, select the OK using the ► button. CANCEL ⇔ OK</p> <ul style="list-style-type: none"> • Please reset the filter time only when you have cleaned or replaced the air filter, for a suitable indication about the air filter. • For the air filter cleaning, see the section "Filter unit" (📖69).

(continued on next page)

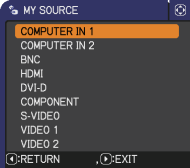
Item	Description
<p>MY BUTTON</p>	<p>This item is to assign one of the following functions to MY BUTTON -(1 to 4) on the remote control (47).</p> <p>(1) Use the ▲/▼ buttons on the MY BUTTON menu to select a MY BUTTON - (1 to 4) and press the ► button to display the MY BUTTON setup dialog.</p> <p>(2) Then using the ▲/▼/◀/▶ buttons sets one of the following functions to the chosen button.</p> <ul style="list-style-type: none"> • COMPUTER IN1: Sets port to COMPUTER IN1. • COMPUTER IN2: Sets port to COMPUTER IN2. • BNC: Sets port to BNC. • HDMI: Sets port to HDMI. • DVI-D: Sets port to DVI-D. • COMPONENT: Sets port to Component (Y, Cb/Pb, Cr/Pr). • S-VIDEO: Sets port to S-VIDEO. • VIDEO 1: Sets port to VIDEO 1. • VIDEO 2: Sets port to VIDEO 2. • INFORMATION: Displays the INPUT -INFORMATION- (55) or the NETWORK -INFORMATION- (55) or nothing. • AUTO KEYSTONE : Performs automatic keystone distortion correction (47). • MY MEMORY: Loads one of adjustment data stored (33). When more than one data are saved, the adjustment changes every time the MY BUTTON is pushed. When no data is saved in memory, the dialog "No saved data" appears. When the current adjustment is not saved to memory, the dialog as shown in the right appears. If you want to keep the current adjustment, please press the ► button to exit. Otherwise loading a data will overwrite the current adjusted condition. • ACTIVE IRIS: Changes the active iris mode. • PICTURE MODE: Changes the PICTURE MODE (29). • FILTER RESET: Displays the filter time reset confirmation dialogue (48). • TEMPLATE: Makes the template pattern selected to the TEMPLATE item (46) appear or disappear. • P by P SWAP: Swaps the picture of right side with left side in the P by P mode. (27) • LENS MEMORY-1: Loads the LENSMEMORY-1 • LENS MEMORY-2: Loads the LENSMEMORY-2 • LENS MEMORY-3: Loads the LENSMEMORY-3 It shifts the lens position in accordance with the memory saved for the type of the present lens unit. When there is no memory for the lens type, this function is ignored. • MY IMAGE: Displays the MY IMAGE menu (59).
<p>MY SOURCE</p>	<p>This item is to assign an input signals to MY SOURCE button on the remote control (22). Using the ▲/▼ buttons sets one of the input signal.</p> 



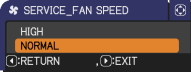
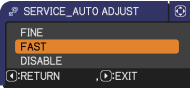
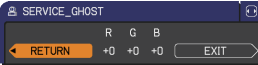
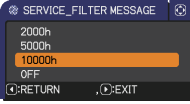

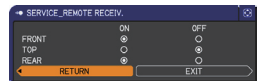
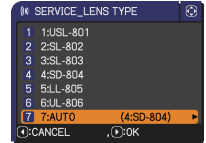

(continued on next page)

Item	Description
<p>SERVICE</p>	<p>Selecting this item displays the SERVICE menu. Select an item using the ▲/▼ buttons, and press the ► button or the ENTER button on the remote control to execute the item.</p> <p>FAN SPEED Using the ▲/▼ buttons switches the rotation speed of the cooling fans. The HIGH is the mode for use at highlands etc. Note that the projector is noisier when the HIGH is selected. HIGH ⇔ NORMAL</p>  <p>AUTO ADJUST Using the ▲/▼ buttons to select one of the mode. When the DISABLE is selected, the automatic adjustment feature is disabled. FINE ⇔ FAST ⇔ DISABLE</p>  <p style="text-align: center;">↑—————↑</p> <p>FINE: Finer tuning including H.SIZE adjustment. FAST: Faster tuning, setting H.SIZE to prearranged data for the input signal.</p> <ul style="list-style-type: none"> Depending on conditions, such as input image, signal cable to the projector, environment around the projector, etc., the automatic adjustment may not work correctly. In such a case, please choose DISABLE to disable the automatic adjustment, and make adjustment manually. <p>GHOST 1. Select a color element of ghost using the ◀/▶ buttons. 2. Adjust the selected element using the ▲/▼ buttons to disappear ghost.</p>  <p>FILTER MESSAGE Use the ▲/▼ button to set the timer for notifying by the message when to replace the filter unit 2000h ⇔ 5000h ⇔ 10000h ⇔ OFF</p>  <p>After choosing an item except OFF, the message “REMINDER *** HRS PASSED AFTER THE LAST FILTER CHANGE” will appear after the timer reaches the interval time set by this feature (71).</p> <p>When the OFF is chosen, the message will not appear. Utilize this feature to keep the air filter clean, setting the suitable time according to your environment of this projector. Refer to the following criterion. 2000h: recommended for use in an indoor environment in a so dusty area, such as a desert or an area in which yellow sands float. 5000h: recommended for use in an indoor environment, such as a place by a window, near a passage. 10000h: recommended for use in a general indoor environment.</p> <ul style="list-style-type: none"> Please take care of the filter unit periodically, even if there is no message. If the air filter becomes to be blocked by dust or other matter, the internal temperature will rise, which could cause malfunction, or reduce the lifetime of the projector. Please be careful with the operating environment of the projector and the condition of the filter unit.

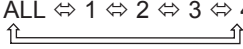

(continued on next page)



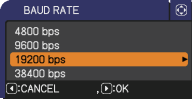
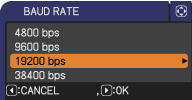

Item	Description
<p>SERVICE (continued)</p>	<p>LENS TYPE Select the lens type currently used using the ▲/▼ buttons. 1:USL-801 ⇄ 2:SL-802 ⇄ 3:SL-803 ⇄ 4:SD-804 ↳ 7:AUTO ⇄ 6:UL-806 ⇄ 5:LL-805 ↵</p> <p>Please select one of them referring to the following. 1: for an ultra short throw lens (USL-801) 2: for a short throw lens (SL-802) 3: for a short throw lens (SL-803) 4: for a standard lens (SD-804) 5: for a long throw lens (LL-805) 6: for an ultra long throw lens (UL-806) 7:AUTO</p> <ul style="list-style-type: none"> • Selecting the lens type will shift the lens to center. While the lens is shifting, the menu will disappears and the icon of hourglass will appears on screen. Shifting may takes some time. • This setting has an influence on the keystone distortion etc. • About the optional lens, ask your dealer.
	<p>LENS LOCK Using the ▲/▼ buttons turns on/off the key lock feature. When ON is selected, the buttons (ZOOM, FOCUS, LENS SHIFT, LENS MEMORY (MY BUTTON)) are locked. ON ⇄ OFF</p>
	<p>KEY LOCK Using the ▲/▼ buttons turns on/off the lens lock feature. When ON is selected, the buttons on the projector except the STANDBY/ON button are locked. ON ⇄ OFF</p> <ul style="list-style-type: none"> • Please use this function to prevent tampering or accidental operation. This function does not have any effect on the remote control.
	<p>REMOTE RECEIV. (1) Select a remote sensor using the ◀/▶ button. 1:FRONT ⇄ 2:TOP ⇄ 3:REAR ↑↑↑↑↑</p> <p>(2) Switch it using the ◀/▶ button. ON ⇄ OFF</p> <ul style="list-style-type: none"> • A sensor cannot be turned off when the other two are off. Always at least one sensor is on.
	<p>REMOTE FREQ. (1) Use the ▲/▼ button to change the projector's remote sensor frequency setting (17). 1:NORMAL ⇄ 2:HIGH</p> <p>(2) Use the ◀/▶ button to change the projector's remote sensor on or off. ON ⇄ OFF</p> <p>The factory default setting is for both 1:NORMAL and 2:HIGH to be on. If the remote control does not function correctly, set the this to either only 1 or only 2 as described in Remote Control Settings (17). Neither can be turned off at the same time.</p>



Item	Description
<p>SERVICE (continued)</p>	<p>REMOTE ID Use the ▲/▼ buttons on the REMOTE ID menu to select ID and press the ► button. ALL ⇔ 1 ⇔ 2 ⇔ 3 ⇔ 4 </p> <p>The projector is controlled by the remote control whose ID button is set the same number as this number. When the ALL is selected, the projector is controlled by a remote control irrespective of the ID setting.</p>
	<p>COMMUNICATION</p> <p>Selecting this item displays COMMUNICATION menu. In this menu, you can configure the communication settings of the CONTROL IN and the CONTROL OUT ports.</p>  <p>COMMUNICATION TYPE ⇔ SERIAL IN SETTING ⇕ COMMUNICATION ID SERIAL OUT SETTING ⇕ COMMUNICATION GROUP TRANSMISSION METHOD ⇕ BYTES INTERVAL TIMEOUT ⇔ RESPONSE LIMIT TIME</p> <ul style="list-style-type: none"> • Select an item using the cursor buttons ▲/▼. Then pressing the ► button opens the submenu for the setting item you selected. Or, pressing the ◀ button instead of the ► button makes the menu back to the previous one without changing the setup. Each submenu can be operated as described above. <div style="border: 1px solid black; border-radius: 15px; padding: 10px;"> <p>NOTE • The selectable items on the COMMUNICATION menu are varied according to the setup of the COMMUNICATION TYPE.</p> <ul style="list-style-type: none"> • For the function of serial communication, refer to the Network Guide ( Network Guide - 3.7, 3.8). </div> <p>COMMUNICATION TYPE In this menu, you can select the communication type for transmission from the CONTROL OUT port.</p>  <p>NETWORK BRIDGE ⇔ DAISY CHAIN ⇔ OFF </p> <p>NETWORK BRIDGE: Select this type, if it is required to control an external device as a network terminal, via this projector from the computer. ( Network Guide - 3.7 Controlling the external equipment via the projector (using the NETWORK BRIDGE function))</p>

Item	Description
<p>SERVICE (continued)</p>	<p>COMMUNICATION (continued)</p> <p>DAISY CHAIN: Select this type, if it is required to connect multiple projectors using a shared RS-232C communication bus, from the computer. (Network Guide - 3.8 Multi-controlling the plural projectors (using DAISY CHAIN function))</p> <p>OFF: Select this mode if you want to output no data from the CONTROL OUT port.</p> <div style="border: 1px solid black; padding: 5px; margin: 10px 0;"> <p>NOTE • OFF is selected as the default setting. • When you select the NETWORK BRIDGE, check the item, TRANSMISSTION METHOD.</p> </div> <p>SERIAL IN SETTING/SERIAL OUT SETTING In these menus, you can select the communication condition for each of the CONTROL IN and CONTROL OUT ports.</p> <p>BAUD RATE 4800 bps ⇄ 9600 bps ⇕ ⇕ 38400 bps ⇄ 19200 bps</p> <p>PARITY NONE ⇄ ODD ⇄ EVEN ⇕ ⇕</p> <p>TRANSMISSION METHOD This menu is available only when the NETWORK BRIDGE is selected for the COMMUNICATION TYPE. Select the transmission method for communication by the NETWORK BRIDGE from the CONTROL OUT port. HALF-DUPLEX ⇄ FULL-DUPLEX</p> <p>HALF-DUPLEX: This method lets the projector make two way communication, but only one direction, either transmitting or receiving data, is allowed at a time. FULL-DUPLEX: This method lets the projector make two way communication, transmitting and receiving data at the same time.</p> <div style="border: 1px solid black; padding: 5px; margin: 10px 0;"> <p>NOTE • HALF-DUPLEX is selected as the default setting. • When you select HALF-DUPLEX, check the items, RESPONSE LIMIT TIME and BYTES INTERVAL TIMEOUT.</p> </div> <div style="display: flex; justify-content: space-around; margin-top: 20px;">   </div>

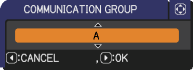
Item	Description
<p>SERVICE (continued)</p>	<p>COMMUNICATION (continued)</p> <p>RESPONSE LIMIT TIME This menu is available only when the NETWORK BRIDGE is selected for the COMMUNICATION TYPE and the HALF-DUPLEX is selected for the TRANSMISSION METHOD. Select the time period to wait for receiving response data from other device communicating by the NETWORK BRIDGE and the HALF-DUPLEX through the CONTROL OUT port. OFF ⇔ 1s ⇔ 2s ⇔ 3s  OFF: Select this mode if it is not required to check the responses from the device that the projector sends data to. In this mode, the projector can send out data from the computer continuously. 1s/2s/3s: Select the time period to keep the projector waiting for response from the device that the projector sends data to. While waiting the response, the projector does not send out any data from the CONTROL OUT port.</p> <p>NOTE • OFF is selected as the default setting.</p> <p>BYTES INTERVAL TIMEOUT This menu is available only when NETWORK BRIDGE is selected for the COMMUNICATION TYPE and HALF-DUPLEX is selected for the TRANSMISSION METHOD. Select the blank time length to judge that the response data has finished in the communicating in the condition of the NETWORK BRIDGE and the HALF-DUPLEX through the CONTROL OUT port. 50ms ⇔ 100ms ⇔ 150ms ⇔ 200ms </p> <p>NOTE • 50ms is selected as the default setting.</p>

Item	Description
<p>COMMUNICATION (continued)</p>	<p>COMMUNICATION GROUP / COMMUNICATION ID This menu is available only when DAISY CHAIN is selected for the COMMUNICATION TYPE. In simultaneous control of multiple projectors by a daisy chain, you can give the projectors the communication group identification and the ID number to identify projectors connected in the same bus. COMMUNICATION GROUP: A ⇄ B ⇄ C ... O ⇄ P  COMMUNICATION ID: 1 ⇄ 2 ⇄ 3 ... 63 ⇄ 64 </p>   <p>NOTE • The A is selected for the COMMUNICATION GROUP, and 1 is selected for the COMMUNICATION ID as the default settings.</p>
<p>SERVICE (continued)</p>	<p>INFORMATION Selecting this item displays a dialog titled “INPUT-INFORMATION-”. It shows the information about the current input.</p>  <ul style="list-style-type: none"> • The “FRAME LOCK” message on the dialog means the frame lock function is working. • The “SCART RGB” message means the Component port is working as a SCART RGB input port. Please refer to the COMPONENT item in INPUT menu (p.37). • This item can't be selected for no signal and sync out. • When the MY TEXT DISPLAY is set to ON, the MY TEXT is displayed together with the input information in the INPUT-INFORMATION- box (p.66). <p>FACTORY RESET Selecting OK using ► the button performs this function. By this function, all the items in all of menus will collectively return to the initial setting. Note that the items LAMP TIME, FILTER TIME, LANGUAGE, SECURITY and NETWORK settings are not reset. CANCEL ⇄ OK</p>

NETWORK menu

Remember that incorrect network settings on this projector may cause trouble on the network. Be sure to consult with your network administrator before connecting to an existing access point on your network.

Select “NETWORK” from the main menu to access the following functions.

Select an item using the ▲/▼ cursor buttons on the projector or remote control, and press the ► cursor button on the projector or remote control, or ENTER button on the remote control to execute the item. Then perform it according to the following table.



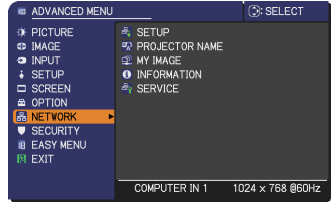

See the User’s Manual - Network Guide for details of NETWORK operation.

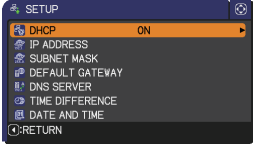
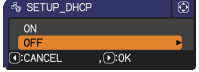

NOTE • If you are not utilizing SNTP (📖 **Date/Time Settings of the User’s Manual - Network Guide**), then you must set the DATE AND TIME during the initial installation.

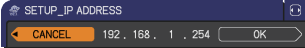
Item	Description	
<p>SETUP</p>	<p>Selecting this item displays the SETUP Menu for the network. Use the ▲/▼ buttons to select an item, and the ► or ENTER button on the remote control to perform the item.</p> 	
	<p>DHCP (Dynamic Host Configuration Protocol)</p>	<p>Use the ▲/▼ buttons to turn DHCP on/off. ON ⇄ OFF</p> <p>Select OFF when the network does not have DHCP enabled.</p> <ul style="list-style-type: none"> • When the “DHCP” setting changes to “ON”, it takes a little time to obtain IP address from DHCP server. • Auto IP function will be assigned an IP address if the projector could not obtain an IP address from server even if DHCP is “ON”. 

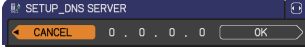
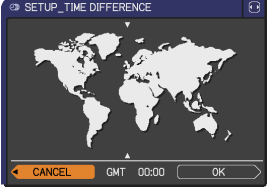
(continued on next page)

Item	Description
SETUP (continued)	<p data-bbox="311 288 418 336" style="text-align: center;">IP ADDRESS</p> <p data-bbox="437 188 676 264">Use the ▲/▼/◀/▶ buttons to enter the IP ADDRESS.</p>  <p data-bbox="437 276 994 323">This function can only be used when DHCP is set to OFF.</p> <ul data-bbox="437 336 1023 440" style="list-style-type: none"> • The IP ADDRESS is the number that identifies this projector on the network. You cannot have two devices with the same IP ADDRESS on the same network. • The IP ADDRESS "0.0.0.0" is prohibited.
	<p data-bbox="311 528 418 576" style="text-align: center;">SUBNET MASK</p> <p data-bbox="437 456 714 560">Use the ▲/▼/◀/▶ buttons to enter the same SUBNET MASK used by your PC.</p>  <p data-bbox="437 571 994 619">This function can only be used when DHCP is set to OFF.</p> <ul data-bbox="437 632 913 655" style="list-style-type: none"> • The SUBNET MASK "0.0.0.0" is prohibited.
	<p data-bbox="311 751 418 783" style="text-align: center;">DEFAULT GATEWAY</p> <p data-bbox="437 671 669 748">Use the ▲/▼/◀/▶ buttons to enter the DEFAULT GATEWAY</p>  <p data-bbox="437 751 964 799">(a node on a computer network that serves as an access point to another network) address.</p> <p data-bbox="437 802 994 850">This function can only be used when DHCP is set to OFF.</p>
	<p data-bbox="311 911 418 959" style="text-align: center;">DNS SERVER</p> <p data-bbox="437 871 703 948">Use the ▲/▼/◀/▶ buttons to input the DNS server address.</p>  <p data-bbox="437 959 1012 1007">The DNS server is a system to control domain names and IP addresses on the Network.</p>
	<p data-bbox="311 1118 418 1166" style="text-align: center;">TIME DIFFERENCE</p> <p data-bbox="437 1031 751 1262">Use the ▲/▼ buttons to enter the TIME DIFFERENCE. Set the same TIME DIFFERENCE as the one set on your PC. If unsure, consult your IT manager. Use the ▶ button to return to the menu after setting the TIME DIFFERENCE.</p> 
	<p data-bbox="331 1350 396 1426" style="text-align: center;">DATE AND TIME</p> <p data-bbox="437 1302 647 1378">Use the ▲/▼/◀/▶ buttons to enter the Year (last two digits), Month, Date, Hour and Minute.</p>  <ul data-bbox="437 1390 1031 1493" style="list-style-type: none"> • The projector will override this setting and retrieve DATE AND TIME information from the Time server when SNTP is enabled. (📘 Date/Time Settings of the User's Manual - Network Guide)

(continued on next page)

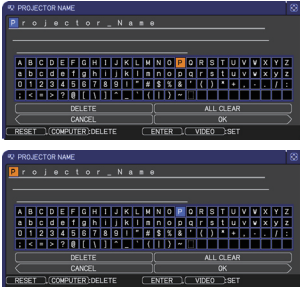

Item	Description
<p>PROJECTOR NAME</p>	<p>(1) Use the ▲/▼ buttons on the NETWORK menu to select the PROJECTOR NAME menu and press the ► button. The PROJECTOR NAME dialog will be displayed.</p>  <p>(2) The current PROJECTOR NAME will be displayed on the first 3 lines. If not yet written, the lines will be blank. Use the ▲/▼/◀/► buttons and the ENTER or VIDEO button to select and enter characters. The RESET or COMPUTER button can be used to erase 1 character at a time. Also if you move the cursor to DELETE or ALL CLEAR on screen and push the ENTER or VIDEO button, 1 character or all characters will be erased. The PROJECTOR NAME can be input up to 64 characters.</p> <p>(3) To change an already inserted character, press the ▲/▼ button to move the cursor to one of the first 3 lines, and use the ◀/► buttons to move the cursor on the character to be changed. After pressing the ENTER or VIDEO button, the character is selected.</p>  <p>Then, follow the same procedure as described at the item (2) above.</p> <p>(4) To finish entering text, move the cursor to the OK on screen and press the ►, ENTER or VIDEO button. To revert to the previous PROJECTOR NAME without saving changes, move the cursor to the CANCEL on screen and press the ◀, ENTER or VIDEO button.</p>

(continued on next page)

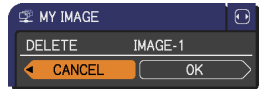
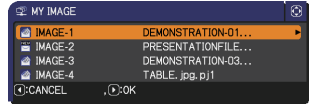
Item	Description
<p>MY IMAGE</p>	<p>Selecting this item displays the MY IMAGE menu.</p> <p>The application software “PImage” is required to store image(s) into the projector.</p> <p>Use the ▲/▼ buttons to select an item which is a still image by the MY IMAGE (MY IMAGE (Still Image Transfer) Display of the User’s Manual - Network Guide) and the ► or ENTER button to display the image.</p> <ul style="list-style-type: none"> • The item without image stored cannot be selected. • The image names are each displayed in 16 characters or less. <p>To switch the image displayed</p> <p>Use the ▲/▼ buttons.</p> <p>To return to the menu</p> <p>Press the ◀ button on the remote control.</p> <p>To erase the image displayed and its source file in the projector.</p> <p>(1) Press the RESET button on the remote control while displaying an image to display the MY IMAGE DELETE menu.</p> <p>(2) Press the ► button to perform to erase. To stop erasing, press the ◀ button.</p>

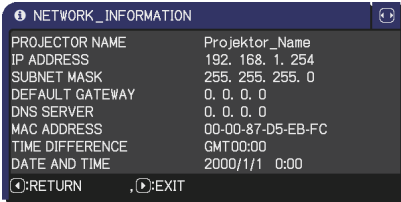

(continued on next page)

Item	Description
<p>INFORMATION</p>	<p>Selecting this item displays the NETWORK -INFORMATION- dialog for confirming the network settings.</p>  <ul style="list-style-type: none"> • Only the first 16 characters of the projector name are displayed. • Nothing (blank) is shown in the “PROJECTOR NAME” field until you setup the item (58). • When the voltage level of the battery for the built in clock decreases, the set time may become incorrect even though accurate date and time are input. Replace the battery suitably (70). • IP ADDRESS, SUBNET MASK and DEFAULT GATEWAY indicate “0.0.0.0” when DHCP is ON and the projector has not gotten address from DHCP server.
<p>SERVICE</p>	<p>Executing this item restarts and initializes the network functions. Choose the RESTART EXECUTE using the button ►.</p>  <p>Then use the button ► to execute.</p>  <p>Network will be once cut off when choose restart. If DHCP is selected on, IP address may be changed. After selecting RESTART EXECUTE, NETWORK menu may not be controlled approx. 30 seconds.</p>

SECURITY menu

This projector is equipped with security functions. From the SECURITY menu, items shown in the table below can be performed.

To use SECURITY menu: User registration is required before using the security functions.

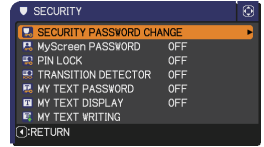

Enter the SECURITY menu

1. Use the ▲/▼ buttons on the SECURITY menu to select ENTER PASSWORD and press the ► button. The ENTER PASSWORD box will be displayed.

If you have forgotten your password

1. While the ENTER PASSWORD box is displayed, press and hold the **RESET** button on the remote control for about 3 seconds or press and hold the **COMPUTER** button for 3 seconds while pressing the ► button on the projector.
2. The 10 digit Inquiring Code will be displayed. Contact your dealer with the 10 digit Inquiring Code. Your password will be sent after your user registration information is confirmed.

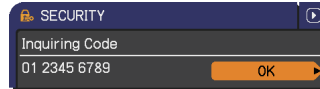

- If there is no key input for about 55 seconds while the Inquiring Code is displayed, the menu will close. If necessary, repeat the process from 1.

2. Use the ▲/▼/◀/▶ buttons to enter the registered password. The factory default password is **9630**. This password can be changed (🔑 SECURITY PASSWORD CHANGE). Move the cursor to the right side of the ENTER PASSWORD box and press the ► button to display the SECURITY menu.

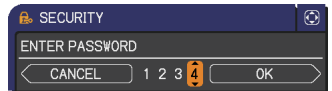

- It is strongly recommended the factory default password to be changed as soon as possible.
- If an incorrect password is input, the ENTER PASSWORD box will be displayed again. If incorrect password is input 3 times, the projector will turn off. Afterwards the projector will turn off every time an incorrect password is input.

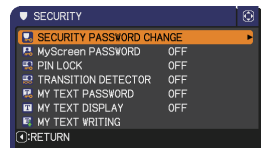

3. Items shown in the table below can be performed.

Item	Description
<p>SECURITY PASSWORD CHANGE</p>	<ol style="list-style-type: none"> 1 Use the ▲/▼ buttons on the SECURITY menu to select SECURITY PASSWORD CHANGE and press the ► button to display the ENTER NEW PASSWORD box. 2 Use the ▲/▼/◀/▶ buttons to enter the new password. 3 Move the cursor to the right side of the ENTER NEW PASSWORD box and press the ► button to display the NEW PASSWORD AGAIN box, enter the same password again. 4 Move the cursor to the right side of the NEW PASSWORD AGAIN box and press the ► button and the NOTE NEW PASSWORD box will be displayed for about 20 seconds, please make note of the password during this time. <ul style="list-style-type: none"> • Pressing the ENTER button on the remote control or ► button on the projector will close the NOTE NEW PASSWORD box. • Please do not forget your password.

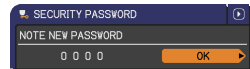

Item	Description
<p>MyScreen PASSWORD</p>	<p>The MyScreen PASSWORD function can be used to prohibit access to the MyScreen function and prevent the currently registered MyScreen image from being overwritten.</p> <p>1 Turning on the MyScreen PASSWORD</p> <p>1-1 Use the ▲/▼ buttons on the SECURITY menu to select MyScreen PASSWORD and press the ► button to display the MyScreen PASSWORD on/off menu.</p> <p>1-2 Use the ▲/▼ buttons on the MyScreen PASSWORD on/off menu to select ON. The ENTER NEW PASSWORD box (small) will be displayed.</p> <p>1-3 Use the ▲/▼/◀/▶ buttons to enter the password. Move the cursor to the right side of the ENTER NEW PASSWORD box (small) and press the ► button to display the NEW PASSWORD AGAIN box, enter the same PASSWORD again.</p> <p>1-4 Move the cursor to the right side of the NEW PASSWORD AGAIN box and press the ► button to display the NOTE NEW PASSWORD box for about 20 seconds, please make note of the password during this time.</p> <ul style="list-style-type: none"> Pressing the ENTER button on the remote control or ► button on the projector will return to MyScreen PASSWORD on/off menu. <p>When a password is set for MyScreen:</p> <ul style="list-style-type: none"> The MyScreen registration function (and menu) will be unavailable. The MyScreen Lock menu will be unavailable. The START UP setting will be locked on MyScreen (and the menu will be unavailable). <p>Turning the MyScreen PASSWORD off will allow normal operation of these functions.</p> <ul style="list-style-type: none"> Please do not forget your MyScreen PASSWORD. <p>2 Turning off the MyScreen PASSWORD</p> <p>2-1 Follow the procedure in 1-1 to display the MyScreen PASSWORD on/off menu.</p> <p>2-2 Select OFF to display the ENTER PASSWORD box (large). Enter the registered password and the screen will return to the MyScreen on/off menu.</p> <p>If an incorrect PASSWORD is input, the menu will close. If necessary, repeat the process from 2-1.</p> <p>3 If you have forgotten your password</p> <p>3-1 Follow the procedure in 1-1 to display the MyScreen PASSWORD on/off menu.</p> <p>3-2 Select OFF to display the ENTER PASSWORD box (large). The 10 digit Inquiring Code will be displayed inside the box.</p> <p>3-3 Contact your dealer with the 10 digit Inquiring Code. Your password will be sent after your user registration information is confirmed.</p>



ENTER NEW PASSWORD box (small)

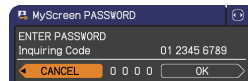
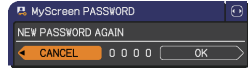



ENTER PASSWORD box (large)

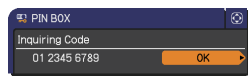
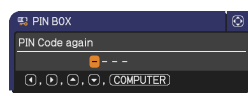
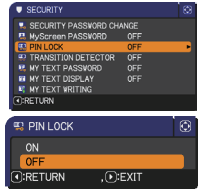

(continued on next page)

Item	Description
<p>PIN LOCK</p>	<p>PIN LOCK is a function which prevents the projector from being used unless a registered Code is input.</p> <p>1 Turning on the PIN LOCK</p> <p>1-1 Use the ▲/▼ buttons on the SECURITY menu to select PIN LOCK and press the ► button or the ENTER button to display the PIN LOCK on/off menu.</p> <p>1-2 Use the ▲/▼ buttons on the PIN LOCK on/off menu to select ON and the Enter PIN Code box will be displayed.</p> <p>1-3 Input a 4 part PIN code using the ▲/▼/◀/▶, COMPUTER button. The PIN Code again box will appear. Reenter the same PIN code. This will complete the PIN code registration.</p> <ul style="list-style-type: none"> • If there is no key input for about 55 seconds while the Enter PIN Code box or the PIN Code again box is displayed, the menu will close. If necessary, repeat the process from 1-1. <p>Afterwards, anytime the projector is restarted after the power switch is turned off the Enter PIN Code box will be displayed. Enter the registered PIN code. The projector can be used after entering the registered PIN code. If an incorrect PIN code is input, the Enter PIN code box will be displayed again.</p> <p>If an incorrect PIN Code is input 3 times, the projector will turn off. Afterwards the projector will turn off every time an incorrect PIN code is input. The projector will also turn off if there is no key input for about 5 minutes while the Enter PIN Code box is displayed. This function will activate only when the projector is started after the power switch was turned off.</p> <ul style="list-style-type: none"> • Please do not forget your PIN code. <p>2 Turning off the PIN LOCK</p> <p>2-1 Follow the procedure in 1-1 to display the PIN LOCK on/off menu. Use the ▲/▼ buttons to select OFF and the Enter PIN Code box will be displayed. Enter the registered PIN code to turn the PIN LOCK function off.</p> <p>If an incorrect password is input 3 times, the menu will close.</p> <p>3 If you have forgotten your PIN Code</p> <p>3-1 While the Enter PIN Code box is displayed, press and hold the RESET button for three seconds or press and hold the COMPUTER button for 3 seconds while pressing the ► button on the projector. The 10 digit Inquiring Code will be displayed.</p> <ul style="list-style-type: none"> • If there is no key input for about 5 minutes while the Inquiring Code is displayed, the projector will turn off. <p>3-2 Contact your dealer with the 10 digit Inquiring Code. Your password will be sent after your user registration information is confirmed.</p>

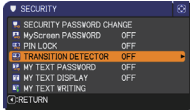
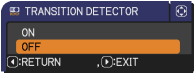

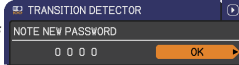
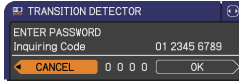
(continued on next page)

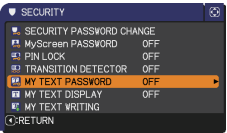
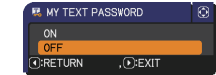
Item	Description
<p>TRANSITION DETECTOR</p>	<p>If this function is set to ON when the vertical angle of the projector or mirror setting at which the projector is turned on is different than the previously recorded, the TRANSITION DETECTOR ON alarm will be displayed and the projector will not display the input signal.</p> <ul style="list-style-type: none"> To display the signal again, set this function OFF. After about 5 minutes of displaying the TRANSITION DETECTOR ON alarm, the lamp will turn off. Keystone adjustment feature has been prohibited as long as the Transition Detector function is on. <p>1 Turning on the TRANSITION DETECTOR</p> <p>1-1 Use the ▲/▼ buttons on the SECURITY menu to select TRANSITION DETECTOR and press the ► or the ENTER button to display the TRANSITION DETECTOR on/off menu.</p> <p>1-2 Use the ▲/▼ buttons on the TRANSITION DETECTOR on/off menu to select ON. Select ON and the current angle and mirror setting will be recorded. The ENTER NEW PASSWORD box (small) will be displayed.</p> <p>1-3 Use the ▲/▼/◀/▶ buttons to enter a password. Move the cursor to the right side of the ENTER NEW PASSWORD box (small) and press the ► button to display the NEW PASSWORD AGAIN box, enter the same password again.</p> <p>1-4 Move the cursor to the right side of the NEW PASSWORD AGAIN box and press the ► button to display the NOTE NEW PASSWORD box for about 20 seconds, please make note of the password during this time.</p> <ul style="list-style-type: none"> Pressing the ENTER button on the remote control or the ► button on the projector will return to the TRANSITION DETECTOR on/off menu. Please do not forget your TRANSITION DETECTOR password. <ul style="list-style-type: none"> This function will activate only when the projector is started after the power switch was turned off. This feature may not function properly if the projector is not in a stable position when ON is selected. <p>2 Turning off the TRANSITION DETECTOR</p> <p>2-1 Follow the procedure in 1-1 to display the Transition Detector on/off menu.</p> <p>2-2 Select OFF to display the ENTER PASSWORD box (large). Enter the registered password and the screen will return to the TRANSITION DETECTOR on/off menu.</p> <p>If an incorrect password is input, the menu will close. If necessary, repeat the process from 2-1.</p> <p>3 If you have forgotten your password</p> <p>3-1 Follow the procedure in 1-1 to display the Transition Detector on/off menu.</p> <p>3-2 Select OFF to display the ENTER PASSWORD box (large). The 10 digit Inquiring Code will be displayed inside the box.</p> <p>3-3 Contact your dealer with the 10 digit Inquiring Code. Your password will be sent after your user registration information is confirmed.</p>
	<div data-bbox="841 185 1031 309" style="border: 1px solid red; padding: 5px; margin-bottom: 10px;"> <p style="text-align: center; color: red;">-<<TRANSITION DETECTOR ON>>-</p> <p style="text-align: center; color: red; font-size: small;">The projector has been transferred from previously installed position.</p> <p style="text-align: center; color: red; font-size: x-small;">If you wish to have a square image on screen again, disable Transition Detector on Menu.</p> </div> <div style="display: flex; justify-content: space-between;"> <div style="width: 65%;">      </div> <div style="width: 30%;"> <p style="margin-top: 10px;">ENTER NEW PASSWORD box (small)</p> <p style="margin-top: 10px;">NEW PASSWORD AGAIN</p> <p style="margin-top: 10px;">NOTE NEW PASSWORD</p> </div> </div> <div style="margin-top: 10px;">  <p style="margin-top: 5px;">ENTER PASSWORD box (large)</p> </div>

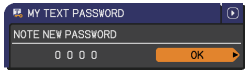
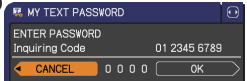
Item	Description
<p>MY TEXT PASSWORD</p>	<p>The MY TEXT PASSWORD function can prevent the MY TEXT from being overwritten. When the password is set for the MY TEXT;</p> <ul style="list-style-type: none"> • The MY TEXT DISPLAY menu will be unavailable, which can prohibit changing the DISPLAY setting. • The MY TEXT WRITING menu will be unavailable, which can prevent the MY TEXT from being overwritten. <p>1 Turning on the MY TEXT PASSWORD</p> <p>1-1 Use the ▲/▼ buttons on the SECURITY menu to select the MY TEXT PASSWORD menu and press the ► button to display the MY TEXT PASSWORD on/off menu.</p>  <p>1-2 Use the ▲/▼ buttons on the MY TEXT PASSWORD menu to select ON. The ENTER NEW PASSWORD box (small) will be displayed.</p>  <p>1-3 Use the ▲/▼/◀/▶ buttons to enter the password. Move the cursor to the right side of the ENTER NEW PASSWORD box (small) and press the ► button to display the NEW PASSWORD AGAIN box, and then enter the same password again.</p>  <p style="text-align: center;">ENTER NEW PASSWORD BOX (small)</p> <p>1-4 Move the cursor to the right side of the NEW PASSWORD AGAIN box and press ► button to display the NOTE PASSWORD box for about 20 seconds, then please make note of the password during this time.</p> <ul style="list-style-type: none"> • Pressing the ENTER button on the remote control or ► button on the projector will return to the MY TEXT PASSWORD on/off menu.   <p>2 Turning off the MY TEXT PASSWORD</p> <p>2-1 Follow the procedure in 1-1 to display the MY TEXT PASSWORD on/off menu.</p> <p>2-2 Select OFF to display the ENTER PASSWORD box (large). Enter the registered password and the screen will return to the MY TEXT PASSWORD on/off menu.</p>  <p style="text-align: center;">ENTER PASSWORD BOX (large)</p> <p>If an incorrect password is input, the menu will close. If necessary, repeat the process from 2-1</p> <p>3 If you have forgotten your password</p> <p>3-1 Follow the procedure in 1-1 to display the MY TEXT PASSWORD on/off menu.</p> <p>3-2 Select OFF to display the ENTER PASSWORD box (large). The 10 digit inquiring code will be displayed inside the box.</p> <p>3-3 Contact your dealer with the 10 digit inquiring code. Your password will be sent after your user registration information is confirmed.</p>

(continued on next page)

Item	Description
<p>MY TEXT DISPLAY</p>	<ol style="list-style-type: none"> Use the ▲/▼ buttons on the SECURITY menu to select the MY TEXT DISPLAY menu and press the ► button to display the MY TEXT DISPLAY on/off menu. Use the ▲/▼ buttons on the MY TEXT DISPLAY on/off menu to select on or off. ON ⇔ OFF When it is set ON, the MY TEXT will be displayed on the START UP screen and the INPUT- INFORMATION- when the INFORMATION on the SERVICE menu is chosen. <ul style="list-style-type: none"> This function is available only when the MY TEXT PASSWORD function is set to the OFF.
<p>MY TEXT WRITING</p>	<ol style="list-style-type: none"> Use the ▲/▼ buttons on the SECURITY menu to select the MY TEXT WRITING menu and press the ► button. The MY TEXT WRITING dialog will be displayed. The current MY TEXT will be displayed on the first 3 lines. If not yet written, the lines will be blank. Use the ▲/▼/◀/▶ buttons and the ENTER or VIDEO button to select and enter characters. The RESET button can be used to erase 1 character at a time. Also if you move the cursor to DELETE or ALL CLEAR on screen and push the ENTER or VIDEO button, 1 character or all characters will be erased. The MY TEXT can be input up to 24 characters on each line. To change an already inserted character, press the ▲/▼ button to move the cursor to one of the first 3 lines, and use the ◀/▶ buttons to move the cursor on the character to be changed. After pressing the ENTER or VIDEO button, the character is selected. Then, follow the same procedure as described at the item 2 above. To finish entering text, move the cursor to the OK on screen and press the ENTER or VIDEO button. To revert to the previous MY TEXT without saving changes, move the cursor to the CANCEL on screen and press the ENTER or VIDEO button. <ul style="list-style-type: none"> The MY TEXT WRITING function is available only when the MY TEXT PASSWORD function is set to OFF.

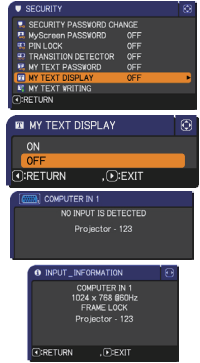

Maintenance

Lamp unit

A worn out lamp bulb could burn or burst. It is recommended to keep a spare lamp unit on hand and to replace the lamp unit when the projected image darkens or color reproduction becomes poor.

To prepare the spare, contact your dealer and tell the following type number.

Type number of the optional lamp unit: DT01001

If the projector is installed in a special state such as ceiling mount, or if the lamp bulb has broken, also ask the dealer to replace the lamp unit. Otherwise, follow the procedure shown below to replace the lamp.

1. Make sure that the projector is unplugged and cooled down.
2. Loosen the screw (marked by arrow) of the lamp cover. Then slide and take it off.
3. Loosen the 3 screws (marked by arrow) of the lamp unit. Then picking the handles of the unit, gently take it from the projector.
4. Gently set the new lamp unit into place. Then retighten the screws of the lamp unit.
5. Put the lamp cover back into place, and retighten the screw of the lamp cover.
6. Reset the LAMP TIME value.
 - (1) Turn the projector on.
 - (2) To display the **ADVANCED MENU**, press the **MENU** button (on the control panel or the remote control). On the **EASY MENU**, select the “**ADVANCED MENU**” using the ▲/▼ cursor buttons, then press the ► cursor button.
 - (3) To select the **OPTION** menu, select the “**OPTION**” using the ▲/▼ cursor buttons in the left column, then press the ► cursor button.
 - (4) To display the **LAMP TIME** dialog, select the “**LAMP TIME**” using the ▲/▼ cursor buttons in the right column, then press the ► cursor button.
 - (5) Use the ► cursor button according to the dialog, Selecting “**OK**” resets the **LAMP TIME** value.

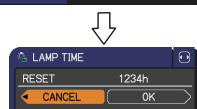
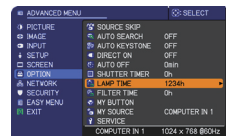
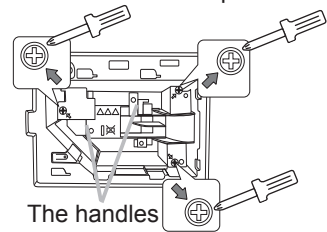
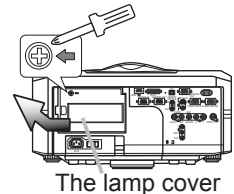

NOTE • The value shown on the OPTION menu as the LAMP TIME is the use time that is counted since the last time the LAMP TIME was reset. Refer to the value for proper maintenance.

NOTICE ► Be sure to reset the LAMP TIME only when you have replaced the lamp unit.

Lamp warning

 HIGH VOLTAGE  HIGH TEMPERATURE  HIGH PRESSURE

⚠ WARNING ▶ The projector uses a high-pressure mercury glass lamp. The lamp can break with a loud bang, or burn out, if jolted or scratched, handled while hot, or worn over time. Note that each lamp has a different lifetime, and some may burst or burn out soon after you start using them. In addition, when the bulb bursts, it is possible for shards of glass to fly into the lamp housing, and for gas containing mercury to escape from the projector's vent holes.

▶ **About disposal of a lamp:** This product contains a mercury lamp; do not put it in a trash. Dispose of it in accordance with environmental laws.

- For lamp recycling, go to www.lamprecycle.org (in the US).
- For product disposal, contact your local government agency or www.eiae.org (in the US) or www.epsc.ca (in Canada).

For more information, call your dealer.



Disconnect the plug from the power outlet

- If the lamp should break (it will make a loud bang when it does), unplug the power cord from the outlet, and make sure to request a replacement lamp from your local dealer. Note that shards of glass could damage the projector's internals, or cause injury during handling, so please do not try to clean the projector or replace the lamp yourself.
- If the lamp should break (it will make a loud bang when it does), ventilate the room well, and make sure not to breathe the gas that comes out of the projector vents, or get it in your eyes or mouth.
- Before replacing the lamp, turn the projector off and unplug the power cord, then wait at least 45 minutes for the lamp to cool sufficiently. Handling the lamp while hot can cause burns, as well as damaging the lamp.



- Never unscrew except the appointed (marked by an arrow) screws.
- Do not open the lamp cover while the projector is suspended from a ceiling. This is dangerous, since if the lamp's bulb has broken, the shards will fall out when the cover is opened. In addition, working in high places is dangerous, so ask your local dealer to have the lamp replaced even if the bulb is not broken.
- Do not use the projector with the lamp cover removed. At the lamp replacing, make sure that the screws are screwed in firmly. Loose screws could result in damage or injury.



- Use only the lamp of the specified type.
- If the lamp breaks soon after the first time it is used, it is possible that there are electrical problems elsewhere besides the lamp. If this happens, contact your local dealer or a service representative.
- Handle with care: jolting or scratching could cause the lamp bulb to burst during use.
- Using the lamp for long periods of time, could cause it to darken, not to light up or to burst. When the pictures appear dark, or when the color tone is poor, please replace the lamp as soon as possible. Do not use old (used) lamps; this is a cause of breakage.

Filter unit

To keep inside ventilation normal, keep a spare and replace the filter unit periodically, although frequent replacement is not needed for this product. To prepare the spare, contact your dealer and tell the following type number.

Type number of the optional filter unit: MU06351

The following walks you through the steps to replace the filter unit.

1. Make sure that the projector is unplugged and cooled down.
2. Use a vacuum cleaner on and around the filter cover.
3. Pick and pull up the filter cover knobs to take it off.
4. Pinch and pull out the filter unit knob to take it off.
5. Use a vacuum cleaner on and around the intake vents of the projector.
6. Set the new filter unit into the place.
7. Put the filter cover back into the place.
8. Reset the FILTER TIME value.

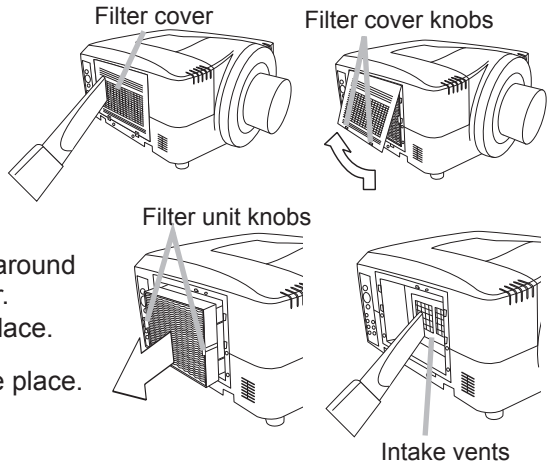

- (1) Turn the projector on.
- (2) To display the EASY MENU, press the MENU button (on the control panel or the remote control). On the ADVANCED MENU, select the “EASY MENU” using the ▲/▼ cursor buttons in the left column, then press the ► cursor button.
- (3) To display the FILTER TIME dialog, select the “FILTER TIME” using the ▲/▼ cursor buttons, then press the ► cursor button.
- (4) Use the ► cursor button according to the dialog. Selecting “OK” resets the FILTER TIME value.

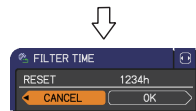
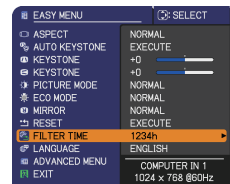

NOTE • The value shown on the EASY menu as the FILTER TIME is the use time that is counted since the last time the FILTER TIME was reset. Refer to the value for proper maintenance.

• You can utilize the message function, which is set up by the item FILTER TIME of the OPTION menu, to notify you when to replace the lamp.

⚠ WARNING ► Before checking or replacing the filter unit, turn off, unplug, and cool down the projector.

► To keep inside ventilation normal, check and replace the filter unit periodically.

► Use only the manufacturer specified type of the filter unit.

NOTICE ► Be sure to reset the FILTER TIME only when you have replaced the filter unit.

Internal clock battery

This projector is being loaded with a battery for the internal clock that the network function needs. When the clock does not work correctly, request your dealer to check the battery and to replace if needed. For replacement, prepare a new battery of the following type. You can buy it at the store or order it from your dealer.

HITACHI MAXELL, part number CR2032 or CR2032H

⚠ WARNING ▶ Be careful of handling battery, since a battery can cause explosion, cracking or leakage that could result in a fire, an injury, and environment pollution.

- Use only the specified battery.
- When replacing the battery, replace it with a new battery.
- Do not use a battery with damage, such as scratches, dents, rust or leakage.
- Do not work on a battery; for example recharging or soldering.
- Keep a battery in a dark, cool and dry place. Never expose a battery to a fire or water.
- Keep a battery away from children and pets. Be careful for them not to swallow a battery.
- When a battery leaked, wipe the leakage out well with a waste cloth. If the leakage adhered to your body, immediately rinse it well with water. When a battery leaked in the battery holder, replace the batteries after wiping the leakage out.
- Obey the local laws on disposing a battery.

Others

For the lens

Be careful not to scratch, crack, dirty, or fog the lens surface, since it affects the image quality. When the lens surface is fogged or dirty, gently wipe it only with the commercial cloth or paper lens cleaner.

For the inside of the projector

In order to ensure the safe use of your projector, please have it cleaned and inspected by your dealer about once every year.

For the cabinet of the projector and remote control

For the dirty cabinet of the projector or remote control, use soft cloth. Dip a soft cloth in water or a neutral cleaner diluted in water, and wipe the cabinet lightly after wringing it well. Then, wipe again lightly with a soft and dry cloth.

⚠ WARNING ▶ Before checking or cleaning the lens, turn off, unplug, and cool down the projector.

- ▶ Do not scratch the projector and knock it against something. Use special caution for the lens surface.
- ▶ Do not wet the product. Do not let any liquids enter to the inside. Do not use a spray.

NOTICE ▶ Do not directly touch the lens surface with hands.





- ▶ Do not use cleaners or chemicals other than those specified in this manual.

Troubleshooting

Related messages

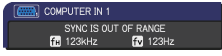
When the unit's power is on, messages such as those shown below may be displayed. When any such message is displayed on the screen, please follow the instructions described below. If the same message is displayed after the remedy, or if a message other than the following appears, please contact your dealer or service company.

Although these messages will automatically disappear after several minutes, they will be displayed again when the power is turned on.

Message	Description
	<p>There is no input signal. Please confirm the signal input connection, and the status of the signal source.</p>
	<p>The horizontal or vertical frequency of the input signal is not within the specified range. Please confirm the specs for your projector or the signal source specs.</p>
	<p>An improper signal is input. Please confirm the specs for your projector or the signal source specs.</p>
	<p>The internal temperature is rising too much. Turn the projector off (U20) soon, and allow it to cool down for 20 minutes or more. After cooling, perform the following check.</p> <ul style="list-style-type: none"> - Are there any obstacles to ventilation around the projector? - Does the temperature around the projector exceed the limit specified? (U77) <p>When this message is displayed without the obstacles mentioned above, replacement of the filter unit is required. Replace the filter unit soon according to the procedure directed in the paragraph "Filter unit" in the chapter "Maintenance" (U69). Remember resetting the FILTER TIME is needed soon after replacement of the filter unit.</p>
	<p>Replacement of the filter unit is required. The value of the timer of the FILTER TIME reached the preset value of the FILTER MESSAGE on the SERVICE menu under the OPTION menu (U50). Replace the filter unit soon according to the procedure directed in the paragraph "Filter unit" in the chapter "Maintenance" (U69). Remember resetting the FILTER TIME is needed soon after replacement of the filter unit.</p>
	<p>The button operation is not available with following condition.</p> <ul style="list-style-type: none"> - While the lens is moving, button operation from the control panel or the remote control might be ignored. Wait for the LENS SHIFT indicator stopping blinking. - Pressing the one of buttons to call a signal input might be ignored, when all the input ports belonging to the category the button's name shows are set to the "SKIP" by the item SOURCE SKIP of the OPTION menu.

Regarding the indicator lamps

Lighting and blinking of the **POWER** indicator, the **TEMP** indicator, the **LAMP** indicator, the **SECURITY** indicator and the **SHUTTER** indicator have the meanings as described in the table below. Please follow the instructions within the table. If the same indication is displayed after the remedy, or if an indication other than the following is displayed, please contact your dealer or service company.

POWER	TEMP	LAMP	SECURITY	SHUTTER	Description
Lighting In Orange	Turned off	Turned off	Turned off	Turned off	The projector is in a standby state. Please refer to the section "Turning on/off".
Blinking In Green	Turned off	Turned off	Turned off	Turned off	The projector is warming up. Please wait.
Lighting In Green	Turned off	Turned off	Turned off	Turned off	The projector is in an on state. Ordinary operations may be performed.
Blinking In Orange	Turned off	Turned off	Turned off	Turned off	The projector is cooling down. Please wait.
Turned off	Turned off	Turned off	Blinking In Red	Turned off	The PIN Lock or (and) TRANSITION DETECTOR is (are) on. Please refer to the description (📖 63,64).
Turned off	Turned off	Turned off	Turned off	Blinking In Yellow	The SHUTTER is closed. Please refer to the description (📖 26).
Blinking In Red	(discretionary)	(discretionary)	Turned off	Turned off	The projector is cooling down. A certain error has been detected. Please wait until the POWER indicator finishes blinking, and then perform the proper measure using the item descriptions below.
Blinking In Red or Lighting In Red	Turned off	Lighting In Red	Turned off	Turned off	The lamp does not light, and there is a possibility that interior portion has become heated. Please turn the power off, and allow the projector to cool down at least 20 minutes. After the projector has sufficiently cooled down, please make confirmation of the following items, and then turn the power on again. <ul style="list-style-type: none"> • Is there blockage of the air passage aperture? • Is the air filter dirty? • Does the peripheral temperature exceed 35°C? If the same indication is displayed after the remedy, please change the lamp referring to the section "Lamp unit".
Blinking In Red or Lighting In Red	Turned off	Blinking In Red	Turned off	Turned off	The lamp cover has not been properly fixed. Please turn the power off, and allow the projector to cool down at least 45 minutes. After the projector has sufficiently cooled down, please make confirmation of the attachment state of the lamp cover. After performing any needed maintenance, turn the power on again. If the same indication is displayed after the remedy, please contact your dealer or service company.

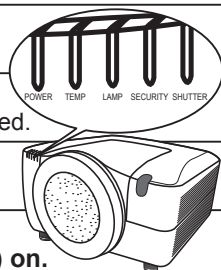

POWER	TEMP	LAMP	SECURITY	SHUTTER	Description
Blinking In Red or Lighting In Red	Blinking In Red	Turned off	Turned off	Turned off	<p>The cooling fan is not operating. Please turn the power off, and allow the projector to cool down at least 20 minutes. After the projector has sufficiently cooled down, please make confirmation that no foreign matter has become caught in the fan, etc., and then turn the power on again. If the same indication is displayed after the remedy, please contact your dealer or service company.</p>
Blinking In Red or Lighting In Red	Lighting In Red	Turned off	Turned off	Turned off	<p>The internal temperature is rising too much. Turn the projector off (🔴20) soon, and allow it to cool down for 20 minutes or more. After cooling, perform the following check. - Are there any obstacles to ventilation around the projector? - Does the temperature around the projector exceed the limit specified? (🔴77) When this message is displayed without the obstacles mentioned above, replacement of the filter unit is required. Replace the filter unit soon according to the procedure directed in the paragraph "Filter unit" in the chapter "Maintenance" (🔴69). Remember resetting the FILTER TIME is needed soon after replacement of the filter unit.</p>
Lighting In Green	Simultaneous blinking in Red		Turned off	Turned off	<p>Replacement of the filter unit is required. The value of the timer of the FILTER TIME reached the preset value of the FILTER MESSAGE on the SERVICE menu under the OPTION menu (🔴50). Replace the filter unit soon according to the procedure directed in the paragraph "Filter unit" in the chapter "Maintenance" (🔴69). Remember resetting the FILTER TIME is needed soon after replacement of the filter unit.</p>
Lighting In Green	Alternative blinking in Red		Turned off	Turned off	<p>There is a possibility that the interior portion has become overcooled. Please use the unit within the usage temperature parameters (5°C to 35°C). After the treatment, reset the power to on.</p>
Blinking in Green for approx. 3 seconds	Turned off	Turned off	Turned off	Turned off	<p>At least 1 "Power ON" schedule is saved to the projector. (Please refer to the 📘User's Manual - Network Guide: Schedule Settings for more information.)</p>

NOTE • When the interior portion has become overheated, for safety purposes, the power source is automatically turned off, and the indicator lamps may also be turned off. In such a case, press the "O" (off) side of the power switch, and wait at least 45 minutes. After the projector has sufficiently cooled down, please make confirmation of the attachment state of the lamp and lamp cover, and then turn the power on again.

Phenomena that may be easily mistaken for machine defects

⚠ WARNING ▶ Never use the projector if abnormal operations such as smoke, strange odor, excessive sound, damaged casing or elements or cables, penetration of liquids or foreign matter, etc. should occur. In such cases, immediately turn off the power switch and then disconnect the power plug from the power outlet. After making sure that the smoke or odor has stopped, contact your dealer or service company.

Before requesting repair, please check in accordance with the following chart. This operation sometimes resolves your problem.

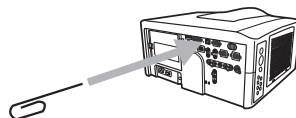

If the situation cannot be corrected;

- The projector's microprocessor may need to be reset. Please push the Shutdown switch by using a pin or similar and the projector will be turned off immediately. Before turning it again, wait at least 10 minutes to make the projector cool down enough.
- Some setting may be wrong. Please use the **FACTORY RESET** function of the **SERVICE** item in the **OPTION** menu (P.55) to reset all settings to factory default. Then, if the problem is not removed after the remedy, please contact your dealer or service company.

Phenomenon	Cases not involving a machine defect	Reference page
Power does not come on.	The electrical power cord is not plugged in. Correctly connect the power cord.	15
	The power switch is not set to the on position. Set the power switch to [] (on).	19
	The main power source has been interrupted during operation such as by a power outage (blackout), etc. Please disconnect the power plug from the power outlet, and allow the projector to cool down at least 10 minutes, then turn the power on again.	19, 20
	Either there is no lamp and/or lamp cover, or either of these has not been properly fixed. Please turn the power off, and allow the projector to cool down at least 45 minutes. After the projector has sufficiently cooled down, please make confirmation of the attachment state of the lamp and lamp cover, and then turn the power on again.	67

(Continued on next page)

Phenomenon	Cases not involving a machine defect	Reference page
No picture is displayed.	The signal cables are not correctly connected. Correctly connect the connection cables.	11
	The brightness is adjusted to an extremely low level. Adjust BRIGHTNESS to a higher level using the menu function or the remote control.	31
	The computer cannot detect the projector as a plug and play monitor. Make sure that the computer can detect a plug and play monitor using another plug and play monitor.	14
	The BLANK screen is displayed. Press the BLANK button on the remote control.	26
	The shutter is closed. Press the SHUTTER button.	26
No pictures or disturbed pictures are displayed on HDMI input.	The HDMI cable is not correctly connected. Correctly connect the HDMI cable.	11
	Your HDMI equipment is not compatible with the projector This projector can be connected with another equipment that has HDMI or DVI connector, but with some equipment the projector may not work properly.	14
	Your HDMI equipment and the projector are not harmonized. Turn off the both equipment, and turn on them again	–
	The signal format on the HDMI is not supported. Check the video setting on your HDMI equipment.	14

(Continued on next page)

Phenomenon	Cases not involving a machine defect	Reference page
Video screen display freezes.	The FREEZE function is working. Press the FREEZE button to restore the screen to normal.	25
Colors have a faded- out appearance, or Color tone is poor.	Color settings are not correctly adjusted. Perform picture adjustments by changing the COLOR TEMP, COLOR, TINT and/or COLOR SPACE settings, using the menu functions.	32, 36
	COLOR SPACE setting is not suitable. Change the COLOR SPACE setting to AUTO, RGB, SMPTE240, REC709 or REC601.	36
Pictures appear dark.	The brightness and/or contrast are adjusted to an extremely low level. Adjust BRIGHTNESS and/or CONTRAST settings to a higher level using the menu function.	31
	The ECO MODE function is working. Select NORMAL for the ECO MODE item in the SETUP menu.	30, 41
	The lamp is approaching the end of its product lifetime. Replace the lamp.	67, 68
Pictures appear blurry.	Either the focus and/or horizontal phase settings are not properly adjusted. Adjust the focus using the FOCUS button, and/or H PHASE using the menu function.	21
	The lens is dirty or misty. Clean the lens referring to the section "For the lens" in "Others".	70
Pictures are trembling.	The exhaust ventilation holes at front is blocked by some objects. Remove any objects from front side of the projector.	10

NOTE • Although bright spots or dark spots may appear on the screen, this is a unique characteristic of liquid crystal displays, and it does not constitute or imply a machine defect.

Warranty and after-service

If a problem occurs with the equipment, first refer to the “Troubleshooting” and run through the suggested checks. If this does not resolve the problem, please contact your dealer or service company. They will tell you what warranty condition is applied.

Specifications

Item	Specifications	
Product name	Liquid crystal projector	
Liquid Crystal Panel	CP-X10000: 1024 horizontal x 768 vertical CP-WX11000: 1366 horizontal x 800 vertical CP-SX12000: 1400 horizontal x 1050 vertical	
Lens	* See the manual of the optional lens.	
Lamp	350W UHB	
Power supply	AC 110-120V/6.0A, AC220-240V/3.1A	
Power consumption	540W	
Temperature range	5 to 35°C (Operating)	
Weight (mass)	13.1kg (approx.)	
Ports	HDMI HDMI jack x 1 DVI-D DVI-D jack x 1 LAN RJ45 jack x 1 MONITOR OUT D-sub 15 pin mini jack x 1 CONTROL IN D-sub 9 pin pulg x 1 CONTROL OUT D-sub 9 pin pulg x 1 REMOTE CONTROL IN 3.5 stereo mini jack x 1 REMOTE CONTROL OUT 3.5 stereo mini jack x 1 S-VIDEO DIN 4 pin mini jack x 1 VIDEO 1 RCA jack x 1 VIDEO 2 BNC jack x 1 COMPUTER IN1 D-sub 15 pin mini jack x 1 COMPUTER IN2 D-sub 15 pin mini jack x 1 BNC (G/Y, B/Cb/Pb, R/Cr/Pr, H, V) BNC jack x 5 Component (Y, Cb/Pb, Cr/Pr) RCA jack x 3	
Optional parts	Lens unit: USL-801 (Ultra short throw lens) SL-802 (Short throw lens) SL-803 (Short throw lens) SD-804(Standard lens) LL-805 (Long throw lens) UL-806 (Ultra long throw lens) Lamp: DT01001 Filter unit: MU06351 Cable cover: CC10000	Lens adapter unit: KU00041 Mounting accessory: HAS-10000 (Bracket for ceiling mount) HAS-204L (Fixing adaptor for low ceilings) HAS-304H (Fixing adaptor for high ceilings) * For further information, check our web site (see below), or ask your dealer.

NOTE • These specifications are subject to change without notice. The latest information is in web site as below.

<http://www.hitachi.us/digitalmedia> or <http://www.hitachidigitalmedia.com>

Specifications (continued)

